



Symbolic Logic

SYMBOLIC LOGIC

By Lewis Carroll

A syllogism worked out.

That story of yours, about your once meeting the sea-serpent, always sets me off yawning;

I never yawn, unless when I'm listening to something totally devoid of interest.

The Premisses, separately.

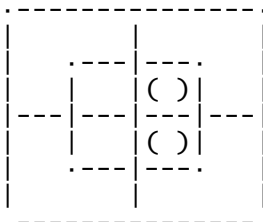
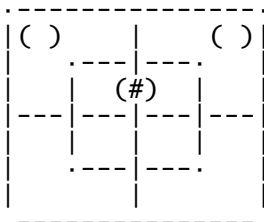

The Premisses, combined.

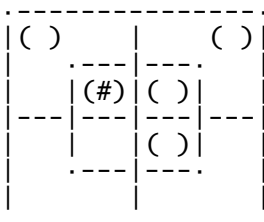

The conclusion.

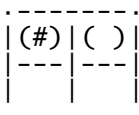

That story of yours, about your once meeting the sea-serpent, is totally devoid of interest.

pg-v

SYMBOLIC LOGIC

PART I

ELEMENTARY

BY

LEWIS CARROLL

Symbolic Logic
SECOND THOUSAND
FOURTH EDITION

PRICE TWO SHILLINGS

London
MACMILLAN AND CO., LIMITED
NEW YORK: THE MACMILLAN COMPANY
1897

All rights reserved

pg-vi

RICHARD CLAY AND SONS, LIMITED,
LONDON AND BUNGAY

pg-vii

ADVERTISEMENT.

An envelope, containing two blank Diagrams (Bilateral and Trilateral) and 9 counters (4 Red and 5 Grey), may be had, from Messrs. Macmillan, for 3_d._, by post 4_d._

* * * * *

I shall be grateful to any Reader of this book who will point out any mistakes or misprints he may happen to notice in it, or any passage which he thinks is not clearly expressed.

* * * * *

I have a quantity of MS. in hand for Parts II and III, and hope to be able----should life, and health, and opportunity, be granted to me, to publish them in the course of the next few years. Their contents will be as follows:--

PART II. ADVANCED.

Further investigations in the subjects of Part I. Propositions of other forms (such as "Not-all x are y"). Trilateral and Multilateral Propositions (such as "All abc are de"). Hypotheticals. Dilemmas. &c. &c.

Part III. TRANSCENDENTAL.

Analysis of a Proposition into its Elements. Numerical and Geometrical Problems. The Theory of Inference. The Construction of Problems. And many other _Curiosa Logica_.

pg-viii

PREFACE TO THE FOURTH EDITION.

The chief alterations, since the First Edition, have been made in the Chapter on 'Classification' (pp. 2, 3) and the Book on 'Propositions' (pp. 10 to 19). The chief additions have been the questions on words and phrases, added to the Examination-Papers at p. 94, and the Notes inserted at pp. 164, 194.

Symbolic Logic

In Book I, Chapter II, I have adopted a new definition of 'Classification', which enables me to regard the whole Universe as a 'Class,' and thus to dispense with the very awkward phrase 'a Set of Things.'

In the Chapter on 'Propositions of Existence' I have adopted a new 'normal form,' in which the Class, whose existence is affirmed or denied, is regarded as the Predicate, instead of the Subject, of the Proposition, thus evading a very subtle difficulty which besets the other form. These subtle difficulties seem to lie at the root of every Tree of Knowledge, and they are far more hopeless to grapple with than any that occur in its higher branches. For example, the difficulties of the Forty-Seventh Proposition of Euclid are mere child's play compared with the mental torture endured in the effort to think out the essential nature of a straight Line. And, in the present work, the difficulties of the "5 Liars" Problem, at p. 192, are "trifles, light as air," compared with the bewildering question "what is a Thing?"

In the Chapter on 'Propositions of Relation' I have inserted a new Section, containing the proof that a Proposition, beginning with "All," is a Double Proposition (a fact that is quite independent of the arbitrary rule, laid down in the next Section, that such a Proposition is to be understood as implying the actual existence of its Subject). This proof was given, in the earlier editions, incidentally, in the course of the discussion of the Biliteral Diagram: but its proper place, in this treatise, is where I have now introduced it.

pg-ix

In the Sorites-Examples, I have made a good many verbal alterations, in order to evade a difficulty, which I fear will have perplexed some of the Readers of the first three Editions. Some of the Premisses were so worded that their Terms were not Specieses of the Univ. named in the Dictionary, but of a larger Class, of which the Univ. was only a portion. In all such cases, it was intended that the Reader should perceive that what was asserted of the larger Class was thereby asserted of the Univ., and should ignore, as superfluous, all that it asserted of its other portion. Thus, in Ex. 15, the Univ. was stated to be "ducks in this village," and the third Premiss was "Mrs. Bond has no gray ducks," i.e. "No gray ducks are ducks belonging to Mrs. Bond." Here the Terms are not Specieses of the Univ., but of the larger Class "ducks," of which the Univ. is only a portion: and it was intended that the Reader should perceive that what is here asserted of "ducks" is thereby asserted of "ducks in this village." and should treat this Premiss as if it were "Mrs. Bond has no gray ducks in this village," and should ignore, as superfluous, what it asserts as to the other portion of the Class "ducks," viz. "Mrs. Bond has no gray ducks out of this village".

In the Appendix I have given a new version of the Problem of the "Five Liars." My object, in doing so, is to escape the subtle and mysterious difficulties which beset all attempts at regarding a Proposition as being its own Subject, or a Set of Propositions as being Subjects for one another. It is certainly, a most bewildering and unsatisfactory theory: one cannot help feeling that there is a great lack of substance in all this shadowy host----that, as the procession of phantoms glides before us, there is not one that we can pounce upon, and say "Here is a Proposition that must be either true or false!"----that it is but a Barmecide Feast, to which we have been bidden----and that its prototype is to be found in that mythical island, whose inhabitants "earned a precarious living by taking in each others' washing"! By simply translating "telling 2 Truths" into "taking both of 2 condiments (salt and mustard)," "telling 2 Lies" into "taking neither of them" and "telling a Truth and a Lie (order not specified)" into "taking only one condiment (it is not specified which)," I have escaped all those metaphysical puzzles, and have produced a Problem which, when translated into a Set of symbolized Premisses, furnishes the very same Data as were furnished by the Problem of the "Five Liars."

pg-x

The coined words, introduced in previous editions, such as "Eliminands"

Symbolic Logic

and "Retinends", perhaps hardly need any apology: they were indispensable to my system: but the new plural, here used for the first time, viz. "Soriteses", will, I fear, be condemned as "bad English", unless I say a word in its defence. We have three singular nouns, in English, of plural form, "series", "species", and "Sorites": in all three, the awkwardness, of using the same word for both singular and plural, must often have been felt: this has been remedied, in the case of "series" by coining the plural "serieses", which has already found its way into the dictionaries: so I am no rash innovator, but am merely "following suit", in using the new plural "Soriteses".

In conclusion, let me point out that even those, who are obliged to study Formal Logic, with a view to being able to answer Examination-Papers in that subject, will find the study of Symbolic Logic most helpful for this purpose, in throwing light upon many of the obscurities with which Formal Logic abounds, and in furnishing a delightfully easy method of testing the results arrived at by the cumbrous processes which Formal Logic enforces upon its votaries.

This is, I believe, the very first attempt (with the exception of my own little book, The Game of Logic, published in 1886, a very incomplete performance) that has been made to popularise this fascinating subject. It has cost me years of hard work: but if it should prove, as I hope it may, to be of real service to the young, and to be taken up, in High Schools and in private families, as a valuable addition to their stock of healthful mental recreations, such a result would more than repay ten times the labour that I have expended on it.

L. C.

29, BEDFORD STREET, STRAND.
Christmas, 1896.

pg-xi

INTRODUCTION.

TO LEARNERS.

[N.B. Some remarks, addressed to Teachers, will be found in the Appendix, at p. 165.]

The Learner, who wishes to try the question fairly, whether this little book does, or does not, supply the materials for a most interesting mental recreation, is earnestly advised to adopt the following Rules:--

(1) Begin at the beginning, and do not allow yourself to gratify a mere idle curiosity by dipping into the book, here and there. This would very likely lead to your throwing it aside, with the remark "This is much too hard for me!", and thus losing the chance of adding a very large item to your stock of mental delights. This Rule (of not dipping) is very desirable with other kinds of books----such as novels, for instance, where you may easily spoil much of the enjoyment you would otherwise get from the story, by dipping into it further on, so that what the author meant to be a pleasant surprise comes to you as a matter of course. Some people, I know, make a practice of looking into Vol. III first, just to see how the story ends: and perhaps it is as well just to know that all ends happily----that the much-persecuted lovers do marry after all, that he is proved to be quite innocent of the murder, that the wicked cousin is completely foiled in his plot and gets the punishment he deserves, and that the rich uncle in India (Qu. Why in India? Ans. Because, somehow, uncles never can get rich anywhere else) dies at exactly the right moment----before taking the trouble to read Vol. I. This, I say, is just permissible with a novel, where Vol. III has a meaning, even for those who have not

Symbolic Logic

read the earlier part of the story; but, with a scientific book, it is sheer insanity: you will find the latter part hopelessly unintelligible, if you read it before reaching it in regular course.

pg-xii

(2) Don't begin any fresh Chapter, or Section, until you are certain that you thoroughly understand the whole book up to that point, and that you have worked, correctly, most if not all of the examples which have been set. So long as you are conscious that all the land you have passed through is absolutely conquered, and that you are leaving no unsolved difficulties behind you, which will be sure to turn up again later on, your triumphal progress will be easy and delightful. Otherwise, you will find your state of puzzlement get worse and worse as you proceed, till you give up the whole thing in utter disgust.

(3) When you come to any passage you don't understand, read it again: if you still don't understand it, read it again: if you fail, even after three readings, very likely your brain is getting a little tired. In that case, put the book away, and take to other occupations, and next day, when you come to it fresh, you will very likely find that it is quite easy.

(4) If possible, find some genial friend, who will read the book along with you, and will talk over the difficulties with you. Talking is a wonderful smoother-over of difficulties. When I come upon anything----in Logic or in any other hard subject----that entirely puzzles me, I find it a capital plan to talk it over, aloud, even when I am all alone. One can explain things so clearly to one's self! And then, you know, one is so patient with one's self: one never gets irritated at one's own stupidity!

If, dear Reader, you will faithfully observe these Rules, and so give my little book a really fair trial, I promise you, most confidently, that you will find Symbolic Logic to be one of the most, if not the most, fascinating of mental recreations! In this First Part, I have carefully avoided all difficulties which seemed to me to be beyond the grasp of an intelligent child of (say) twelve or fourteen years of age. I have myself taught most of its contents, vivâ voce, to many children, and have found them take a real intelligent interest in the subject. For those, who succeed in mastering Part I, and who begin, like Oliver, "asking for more," I hope to provide, in Part II, some tolerably hard nuts to crack----nuts that will require all the nut-crackers they happen to possess!

pg-xiii

Mental recreation is a thing that we all of us need for our mental health; and you may get much healthy enjoyment, no doubt, from Games, such as Back-gammon, Chess, and the new Game "Halma". But, after all, when you have made yourself a first-rate player at any one of these Games, you have nothing real to show for it, as a result! You enjoyed the Game, and the victory, no doubt, at the time: but you have no result that you can treasure up and get real good out of. And, all the while, you have been leaving unexplored a perfect mine of wealth. Once master the machinery of Symbolic Logic, and you have a mental occupation always at hand, of absorbing interest, and one that will be of real use to you in any subject you may take up. It will give you clearness of thought----the ability to see your way through a puzzle----the habit of arranging your ideas in an orderly and get-at-able form----and, more valuable than all, the power to detect fallacies, and to tear to pieces the flimsy illogical arguments, which you will so continually encounter in books, in newspapers, in speeches, and even in sermons, and which so easily delude those who have never taken the trouble to master this fascinating Art. Try it. That is all I ask of you!

L. C.

29, BEDFORD STREET, STRAND.
February 21, 1896.

CONTENTS.

=BOOK I.=

=THINGS AND THEIR ATTRIBUTES.=

CHAPTER I.

INTRODUCTORY.

	PAGE
'=Things='	1
'=Attributes='	"
'=Adjuncts='	"

CHAPTER II.

CLASSIFICATION.

'=Classification='	1½
'=Class='	"
'=Peculiar=' Attributes	"
'=Genus='	"
'=Species='	"
'=Differentia='	"
'=Real=' and '=Unreal=', or '=Imaginary=', Classes	2
'=Individual='	"
A Class regarded as a single Thing	2½

pg-xvi

CHAPTER III.

DIVISION.

§ 1.

Introductory.

'=Division='	3
'=Codivisional=' Classes	"

§ 2.

Dichotomy.

'=Dichotomy='	3½
Arbitrary limits of Classes	"

Subdivision of Classes	Symbolic Logic	4
CHAPTER IV.		
NAMES.		
'=Name='		4½
'=Real=' and '=Unreal=' Names		"
Three ways of expressing a Name		"
Two senses in which a plural Name may be used		5
CHAPTER V.		
DEFINITIONS.		
'=Definition='		6
Examples worked as models		"
pg-xvii		
=BOOK II.=		
=PROPOSITIONS.=		
CHAPTER I.		
PROPOSITIONS GENERALLY.		
§ 1.		
Introductory.		
Technical meaning of "some"		8
'=Proposition='		"
'=Normal form=' of a Proposition		"
'=Subject=', '=Predicate=', and '=Terms='		9
§ 2.		
Normal form of a Proposition.		
Its four parts:--		
(1) '=Sign of Quantity='		9
(2) Name of Subject		"
(3) '=Copula='		"
(4) Name of Predicate		"
§ 3.		
Various kinds of Propositions.		
Three kinds of Propositions:--		

Symbolic Logic

(1) Begins with "Some". Called a '=Particular=' Proposition: also a Proposition '=in I='	10
(2) Begins with "No". Called a '=Universal Negative=' Proposition: also a Proposition '=in E='	"
(3) Begins with "All". Called a '=Universal Affirmative=' Proposition: also a Proposition '=in A='	"
A Proposition, whose Subject is an Individual, is to be regarded as Universal	pg-xviii
Two kinds of Propositions, 'Propositions of Existence', and 'Propositions of Relation'	"
CHAPTER II.	
PROPOSITIONS OF EXISTENCE.	
'=Proposition of Existence ='	11
CHAPTER III.	
PROPOSITIONS OF RELATION.	
§ 1.	
Introductory.	
'=Proposition of Relation='	12
'=Universe of Discourse=,' or '=Univ.='	"
§ 2.	
Reduction of a Proposition of Relation to Normal form.	
Rules	13
Examples worked	"
§ 3.	
A Proposition of Relation, beginning with "All", is a Double Proposition.	
Its equivalence to _two_ Propositions	17
§ 4.	
What is implied, in a Proposition of Relation, as to the Reality of its Terms?	
Propositions beginning with "Some"	19
" " "No"	"
" " "All"	"

Symbolic Logic

§ 5.

Translation of a Proposition of Relation into one or more Propositions of Existence.

Rules	20
Examples worked	"

=BOOK III.=

=THE BILITERAL DIAGRAM.=

CHAPTER I.

SYMBOLS AND CELLS.

The Diagram assigned to a certain Set of Things, viz. our Univ.	22
---	----

Univ. divided into 'the x-Class' and 'the x'-Class'	23
---	----

The North and South Halves assigned to these two Classes	"
--	---

The x-Class subdivided into 'the xy-Class' and 'the xy'-Class'	"
--	---

The North-west and North-East Cells assigned to these two Classes	"
---	---

The x'-Class similarly divided	"
--------------------------------	---

The South-west and South-East Cells similarly assigned	"
--	---

The west and East Halves have thus been assigned to 'the y-Class' and 'the y'-Class'	24
--	----

=Table I.= Attributes of Classes, and Compartments, or Cells, assigned to them	25
--	----

pg-xx

CHAPTER II.

COUNTERS.

Meaning of a Red Counter placed in a Cell	26
---	----

" " " " on a Partition	"
------------------------	---

American phrase "=sitting on the fence="	"
--	---

Meaning of a Grey Counter placed in a Cell	"
--	---

CHAPTER III.

REPRESENTATION OF PROPOSITIONS.

§ 1.

Introductory.

The word "Things" to be henceforwards omitted	27
---	----

	Symbolic Logic	
'=Unilateral=' Proposition		"
'=Bilateral=' do.		"
Proposition '=in terms of=' certain Letters		"
§ 2.		
Representation of Propositions of Existence.		
The Proposition "Some x exist"		28
Three other similar Propositions		"
The Proposition "No x exist"		"
Three other similar Propositions		29
The Proposition "Some xy exist"		"
Three other similar Propositions		"
The Proposition "No xy exist"		"
Three other similar Propositions		"
The Proposition "No x exist" is _Double_, and is equivalent to the two Propositions "No xy exist" and "No xy' exist"		30
		pg-xxi
§ 3.		
Representation of Propositions of Relations.		
The Proposition "Some x are y"		"
Three other similar Propositions		"
The Proposition "Some y are x"		31
Three other similar Propositions		"
Trio of equivalent Propositions, viz. "Some xy exist" = "Some x are y" = "Some y are x"		"
'=Converse=' Propositions, and '=Conversion='		"
Three other similar Trios		32
The Proposition "No x are y"		"
Three other similar Propositions		"
The Proposition "No y are x"		"
Three other similar Propositions		"
Trio of equivalent Propositions, viz. "No xy exist" = "No x are y" = "No y are x"		33
Three other similar Trios		"
The Proposition "All x are y" is _Double_, and is equivalent to the two Propositions "Some x are y" and "No x are _y'_"		"
Seven other similar Propositions		34

=Tables II, III.= Representation of Propositions of Existence and Relation

34, 35

CHAPTER IV.

INTERPRETATION OF BILITERAL DIAGRAM, WHEN MARKED WITH COUNTERS.

Interpretation of $\begin{array}{|c|c|} \hline (.) & \\ \hline \hline \end{array}$ 36

And of three other similar arrangements "

pg-xxii

Interpretation of $\begin{array}{|c|c|} \hline () & \\ \hline \hline \end{array}$ "

And of three other similar arrangements "

Interpretation of $\begin{array}{|c|c|} \hline & (.) \\ \hline \hline \end{array}$ 37

And of three other similar arrangements "

Interpretation of $\begin{array}{|c|c|} \hline (.) & (.) \\ \hline \hline \end{array}$ "

And of three other similar arrangements "

Interpretation of $\begin{array}{|c|c|} \hline () & () \\ \hline \hline \end{array}$ "

And of three other similar arrangements "

Interpretation of $\begin{array}{|c|c|} \hline (.) & () \\ \hline \hline \end{array}$ "

And of seven other similar arrangements 38

=BOOK IV.=

=THE TRILITERAL DIAGRAM.=

CHAPTER I.

SYMBOLS AND CELLS.

Change of Biliteral into Triliteral Diagram 39

	Symbolic Logic	
The xy-Class subdivided into 'the xym-Class' and 'the xym'-Class'	40	pg-xxiii
The Inner and Outer Cells of the North-West Quarter assigned to these Classes	"	
The xy'-Class, the x'y-Class, and the x'y'-Class similarly subdivided	"	
The Inner and Outer Cells of the North-East, the South-West, and the South-East Quarter similarly assigned	"	
The Inner Square and the Outer Border have thus been assigned to 'the m-Class' and 'the _m'_-Class'	"	
Rules for finding readily the Compartment, or Cell, assigned to any given Attribute or Attributes	"	
=Table IV.= Attributes of Classes, and Compartments, or Cells, assigned to them	42	

CHAPTER II.

REPRESENTATION OF PROPOSITIONS IN TERMS OF x AND m, OR OF y AND m.

§ 1.

Representation of Propositions of Existence in terms of x and m, or of y and m.

The Proposition "Some xm exist"	43
Seven other similar Propositions	"
The Proposition "No xm exist"	44
Seven other similar Propositions	"

§ 2.

Representation of Propositions of Relation in terms of x and m, or of y and m.

The Pair of Converse Propositions "Some x are m" = "Some m are x"	"
Seven other similar Pairs	"
The Pair of Converse Propositions "No x are m" = "No m are x"	"
Seven other similar Pairs	"
The Proposition "All x are m"	45
Fifteen other similar Propositions	"
=Tables V, VI, VII, VIII.= Representations of Propositions in terms of x and m, or of y and m	46 to 49

pg-xxiv

CHAPTER III.

Symbolic Logic

_REPRESENTATION OF TWO PROPOSITIONS
OF RELATION, ONE IN TERMS OF x AND m,
AND THE OTHER IN TERMS OF y AND m,
ON THE SAME DIAGRAM._

The Digits "I" and "O" to be used instead of Red and Grey Counters 50

Rules "

Examples worked "

CHAPTER IV.

_INTERPRETATION, IN TERMS OF x AND y,
OF TRILITERAL DIAGRAM, WHEN MARKED
WITH COUNTERS OR DIGITS._

Rules 53

Examples worked 54

=BOOK V.=

=SYLLOGISMS.=

CHAPTER I.

INTRODUCTORY.

'=Syllogism=' 56

'=Premisses=' "

'=Conclusion=' "

'=Eliminands=' 57

'=Retinends=' "

'=Consequent=' "

The Symbol ".'. " "

Specimen-Syllogisms "

pg-xxv

CHAPTER II.

PROBLEMS IN SYLLOGISMS.

§ 1.

Introductory.

'=Concrete=' and '=Abstract=' Propositions 59

Method of translating a Proposition from concrete into abstract form "

Two forms of Problems "

§ 2.

Symbolic Logic

Given a Pair of Propositions of Relation, which contain between them a Pair of codivisional Classes, and which are proposed as Premises: to ascertain what Conclusion, if any, is consequent from them.

Rules	60
Examples worked fully	"
The same worked briefly, as models	64

§ 3.

Given a Trio of Propositions of Relation, of which every two contain a Pair of codivisional Classes, and which are proposed as a Syllogism: to ascertain whether the proposed Conclusion is consequent from the proposed Premises, and, if so, whether it is complete.

Rules	66
Examples worked briefly, as models	"

pg-xxvi

=BOOK VI.=

=THE METHOD OF SUBSCRIPTS.=

CHAPTER I.

INTRODUCTORY.

Meaning of $x_{\{1\}}$, $xy_{\{1\}}$, &c.	70
'=Entity='	"
Meaning of $x_{\{0\}}$, $xy_{\{0\}}$, &c.	"
'=Nullity='	"
The symbols "+" and "¶"	"
'=Like=' and '=unlike=' Signs	"

CHAPTER II.

REPRESENTATION OF PROPOSITIONS OF RELATION.

The Pair of Converse Propositions "Some x are y" = "Some y are x"	71
Three other similar Pairs	"
The Pair of Converse Propositions "No x are y" = "No y are x"	"
Three other similar Pairs	"
The Proposition "All x are y"	72
The Proposition "All x are y" is <u>Double</u> , and is equivalent to the two Propositions "Some x exist" and "No x and y"	"

	Symbolic Logic	
Seven other similar Propositions		"
Rule for translating "All x are y" from abstract into subscript form, and vice versa		"
		pg-xxvii
CHAPTER III.		
SYLLOGISMS.		
§ 1.		
Representation of Syllogisms.		
Rules		73
§ 2.		
Formulæ for Syllogisms.		
Three Formulæ worked out:--		
Fig. I. $xm_{\{0\}} + ym'_{\{0\}} \text{ ¶ } xy_{\{0\}}$		75
its two Variants (a) and (b)		"
Fig. II. $xm_{\{0\}} + ym_{\{1\}} \text{ ¶ } x'y_{\{1\}}$		76
Fig. III. $xm_{\{0\}} + ym_{\{0\}} + m_{\{1\}} \text{ ¶ } x'y'_{\{1\}}$		77
=Table IX.= Formulæ and Rules		78
Examples worked briefly, as models		"
§ 3.		
Fallacies.		
'=Fallacy='		81
Method of finding Forms of Fallacies		82
Forms best stated in _words_		"
Three Forms of Fallacies:--		
(1) Fallacy of Like Eliminands not asserted to exist		"
(2) Fallacy of Unlike Eliminands with an Entity-Premiss		83
(3) Fallacy of two Entity-Premisses		"
§ 4.		
Method of proceeding with a given Pair of Propositions.		
Rules		84
		pg-xxviii
=BOOK VII.=		
=SORITESSES.=		

Symbolic Logic

CHAPTER I.

INTRODUCTORY.

'=Sorites='	85
'=Premisses='	"
'=Partial Conclusion='	"
'=Complete Conclusion=' (or '=Conclusion=')	"
'=Eliminands='	"
'=Retinends='	"
'=consequent='	"
The Symbol "'. '."	"
Specimen-Soriteses	86

CHAPTER II.

PROBLEMS IN SORITESES.

§ 1.

Introductory.

Form of Problem	87
Two Methods of Solution	"

§ 2.

Solution by Method of Separate Syllogisms.

Rules	88
Example worked	"

pg-xxix

§ 3.

Solution by Method of Underscoring.

'=Underscoring='	91
Subscripts to be omitted	"
Example worked fully	92
Example worked briefly, as model	93
Seventeen Examination-Papers	94

=BOOK VIII.=

=EXAMPLES, WITH ANSWERS AND SOLUTIONS.=

CHAPTER I.

Symbolic Logic

EXAMPLES.

§ 1.

Propositions of Relation, to be reduced to normal form 97

§ 2.

_Pairs of Abstract Propositions, one in terms of x and m,
and the other in terms of y and m, to be represented on
the same Triliteral Diagram_ 98

§ 3.

_Marked Triliteral Diagrams, to be interpreted in terms
of x and y_ 99

§ 4.

_Pairs of Abstract Propositions, proposed as Premisses:
Conclusions to be found_ 100

pg-xxx

§ 5.

_Pairs of Concrete Propositions, proposed as Premisses:
Conclusions to be found_ 101

§ 6.

_Trios of Abstract Propositions, proposed as Syllogisms:
to be examined_ 106

§ 7.

_Trios of Concrete Propositions, proposed as Syllogisms:
to be examined_ 107

§ 8.

_Sets of Abstract Propositions, proposed as Premisses for
Soriteses: Conclusions to be found_ 110

§ 9.

_Sets of Concrete Propositions, proposed as Premisses for
Soriteses: Conclusions to be found_ 112

CHAPTER II.

ANSWERS.

Answers to

§ 1 125

§ 2 126

	Symbolic Logic	
§§ 3, 4		127
§ 5		128
§ 6		130
§ 7		131
§§ 8, 9		132
CHAPTER III.		pg-xxx i
SOLUTIONS.		
§ 1.		
Propositions of Relation reduced to normal form.		
Solutions for § 1		134
§ 2.		
Method of Diagrams.		
Solutions for		
§ 4 Nos. 1 to 12		136
§ 5 " 1 to 12		138
§ 6 " 1 to 10		141
§ 7 " 1 to 6		144
§ 3.		
Method of Subscripts.		
Solutions for		
§ 4		146
§ 5 Nos. 13 to 24		147
§§ 6, 7, 8, 9	148 to	157
=NOTES=		164
=APPENDIX, ADDRESSED TO TEACHERS=		165
=NOTES TO APPENDIX=		195
=INDEX.=		
§ 1. Tables		197
§ 2. Words &c. explained		"
		pg-xxxii pg001

Symbolic Logic

BOOK I.

THINGS AND THEIR ATTRIBUTES.

CHAPTER I.

INTRODUCTORY.

The Universe contains '=Things=.'

[For example, "I," "London," "roses," "redness," "old English books," "the letter which I received yesterday."]

Things have '=Attributes=.'

[For example, "large," "red," "old," "which I received yesterday."]

One Thing may have many Attributes; and one Attribute may belong to many Things.

[Thus, the Thing "a rose" may have the Attributes "red," "scented," "full-blown," &c.; and the Attribute "red" may belong to the Things "a rose," "a brick," "a ribbon," &c.]

Any Attribute, or any Set of Attributes, may be called an '=Adjunct=.'

[This word is introduced in order to avoid the constant repetition of the phrase "Attribute or Set of Attributes."]

Thus, we may say that a rose has the Attribute "red" (or the Adjunct "red," whichever we prefer); or we may say that it has the Adjunct "red, scented and full-blown."]

pg001½

CHAPTER II.

CLASSIFICATION.

'Classification,' or the formation of Classes, is a Mental Process, in which we imagine that we have put together, in a group, certain Things. Such a group is called a '=Class=.'

This Process may be performed in three different ways, as follows:--

(1) We may imagine that we have put together all Things. The Class so formed (i.e. the Class "Things") contains the whole Universe.

(2) We may think of the Class "Things," and may imagine that we have picked out from it all the Things which possess a certain Adjunct not possessed by the whole Class. This Adjunct is said to be '=peculiar=' to the Class so formed. In this case, the Class "Things" is called a '=Genus=' with regard to the Class so formed: the Class, so formed, is called a '=Species=' of the Class "Things": and its peculiar Adjunct is called its '=Differentia='.

pg002

As this Process is entirely Mental, we can perform it whether there is, or is not, an existing Thing which possesses that Adjunct. If there is, the Class is said to be '=Real='; if not, it is said to be '=Unreal=', or '=Imaginary='.

[For example, we may imagine that we have picked out, from the

Symbolic Logic

Class "Things," all the Things which possess the Adjunct "material, artificial, consisting of houses and streets"; and we may thus form the Real Class "towns." Here we may regard "Things" as a Genus, "Towns" as a Species of Things, and "material, artificial, consisting of houses and streets" as its Differentia.

Again, we may imagine that we have picked out all the Things which possess the Adjunct "weighing a ton, easily lifted by a baby"; and we may thus form the Imaginary Class "Things that weigh a ton and are easily lifted by a baby."]

(3) We may think of a certain Class, not the Class "Things," and may imagine that we have picked out from it all the Members of it which possess a certain Adjunct not possessed by the whole Class. This Adjunct is said to be '=peculiar=' to the smaller Class so formed. In this case, the Class thought of is called a '=Genus=' with regard to the smaller Class picked out from it: the smaller Class is called a '=Species=' of the larger: and its peculiar Adjunct is called its '=Differentia='.

[For example, we may think of the Class "towns," and imagine that we have picked out from it all the towns which possess the Attribute "lit with gas"; and we may thus form the Real Class "towns lit with gas." Here we may regard "Towns" as a Genus, "Towns lit with gas" as a Species of Towns, and "lit with gas" as its Differentia.

If, in the above example, we were to alter "lit with gas" into "paved with gold," we should get the Imaginary Class "towns paved with gold."]

A Class, containing only one Member is called an '=Individual='.

[For example, the Class "towns having four million inhabitants," which Class contains only one Member, viz. "London."]

Hence, any single Thing, which we can name so as to distinguish it from all other Things, may be regarded as a one-Member Class. pg002½

[Thus "London" may be regarded as the one-Member Class, picked out from the Class "towns," which has, as its Differentia, "having four million inhabitants."]

A Class, containing two or more Members, is sometimes regarded as one single Thing. When so regarded, it may possess an Adjunct which is not possessed by any Member of it taken separately.

[Thus, the Class "The soldiers of the Tenth Regiment," when regarded as one single Thing, may possess the Attribute "formed in square," which is not possessed by any Member of it taken separately.]

pg003

CHAPTER III.

DIVISION.

§ 1.

Introductory.

'Division' is a Mental Process, in which we think of a certain Class of Things, and imagine that we have divided it into two or more smaller Classes.

Symbolic Logic

[Thus, we might think of the Class "books," and imagine that we had divided it into the two smaller Classes "bound books" and "unbound books," or into the three Classes, "books priced at less than a shilling," "shilling-books," "books priced at more than a shilling," or into the twenty-six Classes, "books whose names begin with _A_," "books whose names begin with _B_," &c.]

A Class, that has been obtained by a certain Division, is said to be 'codivisional' with every Class obtained by that Division.

[Thus, the Class "bound books" is codivisional with each of the two Classes, "bound books" and "unbound books."

Similarly, the Battle of Waterloo may be said to have been "contemporary" with every event that happened in 1815.]

Hence a Class, obtained by Division, is codivisional with itself.

[Thus, the Class "bound books" is codivisional with itself.

Similarly, the Battle of Waterloo may be said to have been "contemporary" with itself.]

pg003½

§ 2.

Dichotomy.

If we think of a certain Class, and imagine that we have picked out from it a certain smaller Class, it is evident that the _Remainder_ of the large Class does _not_ possess the Differentia of that smaller Class. Hence it may be regarded as _another_ smaller Class, whose Differentia may be formed, from that of the Class first picked out, by prefixing the word "not"; and we may imagine that we have _divided_ the Class first thought of into _two_ smaller Classes, whose Differentia are _contradictory_. This kind of Division is called '=Dichotomy='.

[For example, we may divide "books" into the two Classes whose Differentia are "old" and "not-old."]

In performing this Process, we may sometimes find that the Attributes we have chosen are used so loosely, in ordinary conversation, that it is not easy to decide _which_ of the Things belong to the one Class and _which_ to the other. In such a case, it would be necessary to lay down some arbitrary _rule_, as to _where_ the one Class should end and the other begin.

[Thus, in dividing "books" into "old" and "not-old," we may say "Let all books printed before A.D. 1801, be regarded as 'old,' and all others as 'not-old'."]

Henceforward let it be understood that, if a Class of Things be divided into two Classes, whose Differentia have contrary meanings, each Differentia is to be regarded as equivalent to the other with the word "not" prefixed.

[Thus, if "books" be divided into "old" and "new" the Attribute "old" is to be regarded as equivalent to "not-new," and the Attribute "new" as equivalent to "not-old."]

pg004

After dividing a Class, by the Process of _Dichotomy_, into two smaller Classes, we may sub-divide each of these into two still smaller Classes; and this Process may be repeated over and over again, the number of Classes being doubled at each repetition.

[For example, we may divide "books" into "old" and "new" (i.e. "_not_-old"): we may then sub-divide each of these into "English" and "foreign" (i.e. "_not_-English"), thus getting

Symbolic Logic

four Classes, viz.

- (1) old English;
- (2) old foreign;
- (3) new English;
- (4) new foreign.

If we had begun by dividing into "English" and "foreign," and had then sub-divided into "old" and "new," the four Classes would have been

- (1) English old;
- (2) English new;
- (3) foreign old;
- (4) foreign new.

The Reader will easily see that these are the very same four Classes which we had before.]

pg004½

CHAPTER IV.

NAMES.

The word "Thing", which conveys the idea of a Thing, without any idea of an Adjunct, represents any single Thing. Any other word (or phrase), which conveys the idea of a Thing, with the idea of an Adjunct represents any Thing which possesses that Adjunct; i.e., it represents any Member of the Class to which that Adjunct is peculiar.

Such a word (or phrase) is called a '=Name='; and, if there be an existing Thing which it represents, it is said to be a Name of that Thing.

[For example, the words "Thing," "Treasure," "Town," and the phrases "valuable Thing," "material artificial Thing consisting of houses and streets," "Town lit with gas," "Town paved with gold," "old English Book."]

Just as a Class is said to be Real, or Unreal, according as there is, or is not, an existing Thing in it, so also a Name is said to be Real, or Unreal, according as there is, or is not, an existing Thing represented by it.

[Thus, "Town lit with gas" is a Real Name: "Town paved with gold" is an Unreal Name.]

Every Name is either a Substantive only, or else a phrase consisting of a Substantive and one or more Adjectives (or phrases used as Adjectives).

Every Name, except "Thing", may usually be expressed in three different forms:--

(a) The Substantive "Thing", and one or more Adjectives (or phrases used as Adjectives) conveying the ideas of the Attributes;

pg005

(b) A Substantive, conveying the idea of a Thing with the ideas of some of the Attributes, and one or more Adjectives (or phrases used as Adjectives) conveying the ideas of the other Attributes;

(c) A Substantive conveying the idea of a Thing with the ideas of all the Attributes.

Symbolic Logic

[Thus, the phrase "material living Thing, belonging to the Animal Kingdom, having two hands and two feet" is a Name expressed in Form (_a_).

If we choose to roll up together the Substantive "Thing" and the Adjectives "material, living, belonging to the Animal Kingdom," so as to make the new Substantive "Animal," we get the phrase "Animal having two hands and two feet," which is a Name (representing the same Thing as before) expressed in Form (_b_).

And, if we choose to roll up the whole phrase into one word, so as to make the new Substantive "Man," we get a Name (still representing the very same Thing) expressed in Form (_c_).]

A Name, whose Substantive is in the _plural_ number, may be used to represent either

(1) Members of a Class, _regarded as separate Things_;
or (2) a whole Class, _regarded as one single Thing_.

[Thus, when I say "Some soldiers of the Tenth Regiment are tall," or "The soldiers of the Tenth Regiment are brave," I am using the Name "soldiers of the Tenth Regiment" in the _first_ sense; and it is just the same as if I were to point to each of them _separately_, and to say "_This_ soldier of the Tenth Regiment is tall," "_That_ soldier of the Tenth Regiment is tall," and so on.

But, when I say "The soldiers of the Tenth Regiment are formed in square," I am using the phrase in the _second_ sense; and it is just the same as if I were to say "The _Tenth Regiment_ is formed in square."]

pg006

CHAPTER V.

DEFINITIONS.

It is evident that every Member of a _Species_ is _also_ a Member of the _Genus_ out of which that Species has been picked, and that it possesses the _Differentia_ of that Species. Hence it may be represented by a Name consisting of two parts, one being a Name representing any Member of the _Genus_, and the other being the _Differentia_ of that Species. Such a Name is called a '=Definition=' of any Member of that Species, and to give it such a Name is to '=define=' it.

[Thus, we may define a "Treasure" as a "valuable Thing." In this case we regard "Things" as the _Genus_, and "valuable" as the _Differentia_.]

The following Examples, of this Process, may be taken as models for working others.

[Note that, in each Definition, the Substantive, representing a Member (or Members) of the _Genus_, is printed in Capitals.]

1. Define "a Treasure."

Ans. "a valuable THING."

2. Define "Treasures."

Ans. "valuable THINGS."

3. Define "a Town."

Symbolic Logic

Ans. "a material artificial THING, consisting of houses and streets."
pg007

4. Define "Men."

Ans. "material, living THINGS, belonging to the Animal Kingdom, having two hands and two feet";

or else

"ANIMALS having two hands and two feet."

5. Define "London."

Ans. "the material artificial THING, which consists of houses and streets, and has four million inhabitants";

or else

"the TOWN which has four million inhabitants."

[Note that we here use the article "the" instead of "a", because we happen to know that there is only one such Thing.

The Reader can set himself any number of Examples of this Process, by simply choosing the Name of any common Thing (such as "house," "tree," "knife"), making a Definition for it, and then testing his answer by referring to any English Dictionary.]

pg008

BOOK II.

PROPOSITIONS.

CHAPTER I.

PROPOSITIONS GENERALLY.

§ 1.

Introductory.

Note that the word "some" is to be regarded, henceforward, as meaning "one or more."

The word 'Proposition,' as used in ordinary conversation, may be applied to any word, or phrase, which conveys any information whatever.

[Thus the words "yes" and "no" are Propositions in the ordinary sense of the word; and so are the phrases "you owe me five farthings" and "I don't!"]

Such words as "oh!" or "never!", and such phrases as "fetch me that book!" "which book do you mean?" do not seem, at first sight, to convey any information; but they can easily be turned into equivalent forms which do so, viz. "I am surprised," "I will never consent to it," "I order you to fetch me that book," "I want to know which book you mean."]

But a '=Proposition=,' as used in this First Part of "Symbolic Logic," has a peculiar form, which may be called its '=Normal form='; and if any Proposition, which we wish to use in an argument, is not in normal form, we must reduce it to such a form, before we can use it.

pg009

Symbolic Logic

A '=Proposition=', when in normal form, asserts, as to certain two Classes, which are called its '=Subject=' and '=Predicate=', either

(1) that some Members of its Subject are Members of its Predicate;

or (2) that no Members of its Subject are Members of its Predicate;

or (3) that all Members of its Subject are Members of its Predicate.

The Subject and the Predicate of a Proposition are called its '=Terms=.'

Two Propositions, which convey the same information, are said to be '=equivalent='.

[Thus, the two Propositions, "I see John" and "John is seen by me," are equivalent.]

§ 2.

Normal form of a Proposition.

A Proposition, in normal form, consists of four parts, viz.--

(1) The word "some," or "no," or "all." (This word, which tells us how many Members of the Subject are also Members of the Predicate, is called the '=Sign of Quantity=.'

(2) Name of Subject.

(3) The verb "are" (or "is"). (This is called the '=Copula=.'

(4) Name of Predicate.

pg010

§ 3.

Various kinds of Propositions.

A Proposition, that begins with "Some", is said to be '=Particular=.' It is also called 'a Proposition =in I=.'

[Note, that it is called 'Particular,' because it refers to a part only of the Subject.]

A Proposition, that begins with "No", is said to be '=Universal Negative=.' It is also called 'a Proposition =in E=.'

A Proposition, that begins with "All", is said to be '=Universal Affirmative=.' It is also called 'a Proposition =in A=.'

[Note, that they are called 'Universal', because they refer to the whole of the Subject.]

A Proposition, whose Subject is an Individual, is to be regarded as Universal.

[Let us take, as an example, the Proposition "John is not well". This of course implies that there is an Individual, to whom the speaker refers when he mentions "John", and whom the listener knows to be referred to. Hence the Class "men" referred to by the speaker when he mentions "John" is a one-Member Class, and the Proposition is equivalent to "All

Symbolic Logic

the men, who are referred to by the speaker when he mentions 'John', are not well."]

Propositions are of two kinds, 'Propositions of Existence' and 'Propositions of Relation.'

These shall be discussed separately.

pg011

CHAPTER II.

PROPOSITIONS OF EXISTENCE.

A '=Proposition of Existence=', when in normal form, has, for its _Subject_, the Class "existing Things".

Its Sign of Quantity is "Some" or "No".

[Note that, though its Sign of Quantity tells us _how many_ existing Things are Members of its Predicate, it does _not_ tell us the _exact_ number: in fact, it only deals with _two_ numbers, which are, in ascending order, "0" and "1 or more."]

It is called "a Proposition of Existence" because its effect is to assert the _Reality_ (i.e. the real _existence_), or else the _Imaginariness_, of its Predicate.

[Thus, the Proposition "Some existing Things are honest men" asserts that the Class "honest men" is _Real_.

This is the _normal_ form; but it may also be expressed in any one of the following forms:--

- (1) "Honest men exist";
- (2) "Some honest men exist";
- (3) "The Class 'honest men' exists";
- (4) "There are honest men";
- (5) "There are some honest men".

Similarly, the Proposition "No existing Things are men fifty feet high" asserts that the Class "men 50 feet high" is _Imaginary_.

This is the _normal_ form; but it may also be expressed in any one of the following forms:--

- (1) "Men 50 feet high do not exist";
- (2) "No men 50 feet high exist";
- (3) "The Class 'men 50 feet high' does not exist";
- (4) "There are not any men 50 feet high";
- (5) "There are no men 50 feet high."]

pg012

CHAPTER III.

PROPOSITIONS OF RELATION.

§ 1.

Introductory.

A '=Proposition of Relation=', of the kind to be here discussed, has, for its Terms, two Specieses of the same Genus, such that each of the two Names conveys the idea of some Attribute _not_ conveyed by the other.

Symbolic Logic

[Thus, the Proposition "Some merchants are misers" is of the right kind, since "merchants" and "misers" are Specieses of the same Genus "men"; and since the Name "merchants" conveys the idea of the Attribute "mercantile", and the name "misers" the idea of the Attribute "miserly", each of which ideas is not conveyed by the other Name.

But the Proposition "Some dogs are setters" is not of the right kind, since, although it is true that "dogs" and "setters" are Specieses of the same Genus "animals", it is not true that the Name "dogs" conveys the idea of any Attribute not conveyed by the Name "setters". Such Propositions will be discussed in Part II.]

The Genus, of which the two Terms are Specieses, is called the '=Universe of Discourse=', or (more briefly) the '=Univ.='

The Sign of Quantity is "Some" or "No" or "All".

[Note that, though its Sign of Quantity tells us how many Members of its Subject are also Members of its Predicate, it does not tell us the exact number: in fact, it only deals with three numbers, which are, in ascending order, "0", "1 or more", "the total number of Members of the Subject".]

It is called "a Proposition of Relation" because its effect is to assert that a certain relationship exists between its Terms.

pg013

§ 2.

Reduction of a Proposition of Relation to Normal form.

The Rules, for doing this, are as follows:--

- (1) Ascertain what is the Subject (i.e., ascertain what Class we are talking about);
- (2) If the verb, governed by the Subject, is not the verb "are" (or "is"), substitute for it a phrase beginning with "are" (or "is");
- (3) Ascertain what is the Predicate (i.e., ascertain what Class it is, which is asserted to contain some, or none, or all, of the Members of the Subject);
- (4) If the Name of each Term is completely expressed (i.e. if it contains a Substantive), there is no need to determine the 'Univ.'; but, if either Name is incompletely expressed, and contains Attributes only, it is then necessary to determine a 'Univ.', in order to insert its Name as the Substantive.
- (5) Ascertain the Sign of Quantity;
- (6) Arrange in the following order:--

Sign of Quantity,
Subject,
Copula,
Predicate.

[Let us work a few Examples, to illustrate these Rules.

(1)

"Some apples are not ripe."

Symbolic Logic

- (1) The Subject is "apples."
- (2) The Verb is "are."
- (3) The Predicate is "not-ripe * * *." (As no Substantive is expressed, and we have not yet settled what the Univ. is to be, we are forced to leave a blank.)
- (4) Let Univ. be "fruit."
- (5) The Sign of Quantity is "some."
- (6) The Proposition now becomes
"Some | apples | are | not-ripe fruit."

pg014

(2)

"None of my speculations have brought me as much as 5 per cent."

- (1) The Subject is "my speculations."
- (2) The Verb is "have brought," for which we substitute the phrase "are * * * that have brought".
- (3) The Predicate is "* * * that have brought &c."
- (4) Let Univ. be "transactions."
- (5) The Sign of Quantity is "none of."
- (6) The Proposition now becomes
"None of | my speculations | are | transactions
that have brought me as much as 5 per cent."

(3)

"None but the brave deserve the fair."

To begin with, we note that the phrase "none but the brave" is equivalent to "no _not_-brave."

- (1) The Subject has for its Attribute "not-brave." But no Substantive is supplied. So we express the Subject as "not-brave * * *."
- (2) The Verb is "deserve," for which we substitute the phrase "are deserving of".
- (3) The Predicate is "* * * deserving of the fair."
- (4) Let Univ. be "persons."
- (5) The Sign of Quantity is "no."
- (6) The Proposition now becomes
"No | not-brave persons | are | persons deserving
of the fair."

(4)

"A lame puppy would not say "thank you" if you offered to lend it a skipping-rope."

Symbolic Logic

(1) The Subject is evidently "lame puppies," and all the rest of the sentence must somehow be packed into the Predicate.

(2) The Verb is "would not say," &c., for which we may substitute the phrase "are not grateful for."

(3) The Predicate may be expressed as "* * * not grateful for the loan of a skipping-rope."

(4) Let Univ. be "puppies."

(5) The Sign of Quantity is "all."

(6) The Proposition now becomes

"All | lame puppies | are | puppies not grateful
for the loan of a skipping-rope."

pg015

(5)

"No one takes in the _Times_, unless he is well-educated."

(1) The Subject is evidently persons who are not well-educated ("no _one_" evidently means "no _person_").

(2) The Verb is "takes in," for which we may substitute the phrase "are persons taking in."

(3) The Predicate is "persons taking in the _Times_."

(4) Let Univ. be "persons."

(5) The Sign of Quantity is "no."

(6) The Proposition now becomes

"No | persons who are not well-educated | are |
persons taking in the _Times_."

(6)

"My carriage will meet you at the station."

(1) The Subject is "my carriage." This, being an 'Individual,' is equivalent to the Class "my carriages." (Note that this Class contains only _one_ Member.)

(2) The Verb is "will meet", for which we may substitute the phrase "are * * * that will meet."

(3) The Predicate is "* * * that will meet you at the station."

(4) Let Univ. be "things."

(5) The Sign of Quantity is "all."

(6) The Proposition now becomes

"All | my carriages | are | things that will meet
you at the station."

(7)

"Happy is the man who does not know what 'toothache' means!"

Symbolic Logic

(1) The Subject is evidently "the man &c." (Note that in this sentence, the Predicate comes first.) At first sight, the Subject seems to be an 'Individual'; but on further consideration, we see that the article "the" does not imply that there is only one such man. Hence the phrase "the man who" is equivalent to "all men who".

(2) The Verb is "are."

(3) The Predicate is "happy * * *."

(4) Let Univ. be "men."

(5) The Sign of Quantity is "all."

(6) The Proposition now becomes

"All | men who do not know what 'toothache'
means | are | happy men."

pg016

(8)

"Some farmers always grumble at the weather, whatever it may be."

(1) The Subject is "farmers."

(2) The Verb is "grumble," for which we substitute the phrase "are * * * who grumble."

(3) The Predicate is "* * * who always grumble &c."

(4) Let Univ. be "persons."

(5) The Sign of Quantity is "some."

(6) The Proposition now becomes

"Some | farmers | are | persons who always
grumble at the weather, whatever it may be."

(9)

"No lambs are accustomed to smoke cigars."

(1) The Subject is "lambs."

(2) The Verb is "are."

(3) The Predicate is "* * * accustomed &c."

(4) Let Univ. be "animals."

(5) The Sign of Quantity is "no."

(6) The Proposition now becomes

"No | lambs | are | animals accustomed to smoke
cigars."

(10)

"I ca'n't understand examples that are not arranged in regular order, like those I am used to."

Symbolic Logic

- (1) The Subject is "examples that," &c.
- (2) The Verb is "I ca'n't understand," which we must alter, so as to have "examples," instead of "I," as the nominative case. It may be expressed as "are not understood by me."
- (3) The Predicate is "* * * not understood by me."
- (4) Let Univ. be "examples."
- (5) The sign of Quantity is "all."
- (6) The Proposition now becomes
"All | examples that are not arranged in regular order like those I am used to | are | examples not understood by me."]

pg017

§ 3.

A Proposition of Relation, beginning with "All", is a Double Proposition.

A Proposition of Relation, beginning with "All", asserts (as we already know) that "All Members of the Subject are Members of the Predicate". This evidently contains, as a part of what it tells us, the smaller Proposition "Some Members of the Subject are Members of the Predicate".

[Thus, the Proposition "All bankers are rich men" evidently contains the smaller Proposition "Some bankers are rich men".]

The question now arises "what is the rest of the information which this Proposition gives us?"

In order to answer this question, let us begin with the smaller Proposition, "Some Members of the Subject are Members of the Predicate," and suppose that this is all we have been told; and let us proceed to inquire what else we need to be told, in order to know that "All Members of the Subject are Members of the Predicate".

[Thus, we may suppose that the Proposition "Some bankers are rich men" is all the information we possess; and we may proceed to inquire what other Proposition needs to be added to it, in order to make up the entire Proposition "All bankers are rich men".]

Let us also suppose that the 'Univ.' (i.e. the Genus, of which both the Subject and the Predicate are Specieses) has been divided (by the Process of Dichotomy) into two smaller Classes, viz.

- (1) the Predicate;
- (2) the Class whose Differentia is contradictory to that of the Predicate.

[Thus, we may suppose that the Genus "men," (of which both "bankers" and "rich men" are Specieses) has been divided into the two smaller Classes, "rich men", "poor men".]

Now we know that every Member of the Subject is (as shown at p. 6) a Member of the Univ. Hence every Member of the Subject is either in Class (1) or else in Class (2). pg018

[Thus, we know that every banker is a Member of the Genus "men". Hence, every banker is either in the Class "rich men",

Symbolic Logic

or else in the Class "poor men".]

Also we have been told that, in the case we are discussing, some Members of the Subject are in Class (1). What else do we need to be told, in order to know that all of them are there? Evidently we need to be told that none of them are in Class (2); i.e. that none of them are Members of the Class whose Differentia is contradictory to that of the Predicate.

[Thus, we may suppose we have been told that some bankers are in the Class "rich men". What else do we need to be told, in order to know that all of them are there? Evidently we need to be told that none of them are in the Class "poor men".]

Hence a Proposition of Relation, beginning with "All", is a Double Proposition, and is '=equivalent=' to (i.e. gives the same information as) the two Propositions

(1) "Some Members of the Subject are Members of the Predicate";

(2) "No Members of the Subject are Members of the Class whose Differentia is contradictory to that of the Predicate".

[Thus, the Proposition "All bankers are rich men" is a Double Proposition, and is equivalent to the two Propositions

(1) "Some bankers are rich men";

(2) "No bankers are poor men".]

pg019

§ 4.

What is implied, in a Proposition of Relation, as to the Reality of its Terms?_

Note that the rules, here laid down, are arbitrary, and only apply to Part I of my "Symbolic Logic."

A Proposition of Relation, beginning with "Some", is henceforward to be understood as asserting that there are some existing Things, which, being Members of the Subject, are also Members of the Predicate; i.e. that some existing Things are Members of both Terms at once. Hence it is to be understood as implying that each Term, taken by itself, is Real.

[Thus, the Proposition "Some rich men are invalids" is to be understood as asserting that some existing Things are "rich invalids". Hence it implies that each of the two Classes, "rich men" and "invalids", taken by itself, is Real.]

A Proposition of Relation, beginning with "No", is henceforward to be understood as asserting that there are no existing Things which, being Members of the Subject, are also Members of the Predicate; i.e. that no existing Things are Members of both Terms at once. But this implies nothing as to the Reality of either Term taken by itself.

[Thus, the Proposition "No mermaids are milliners" is to be understood as asserting that no existing Things are "mermaid-milliners". But this implies nothing as to the Reality, or the Unreality, of either of the two Classes, "mermaids" and "milliners", taken by itself. In this case as it happens, the Subject is Imaginary, and the Predicate Real.]

A Proposition of Relation, beginning with "All", contains (see § 3) a

Symbolic Logic

similar Proposition beginning with "Some". Hence it is to be understood as implying that each Term, taken by itself, is Real.

[Thus, the Proposition "All hyænas are savage animals" contains the Proposition "Some hyænas are savage animals". Hence it implies that each of the two Classes, "hyænas" and "savage animals", taken by itself, is Real.]

pg020

§ 5.

Translation of a Proposition of Relation into one or more Propositions of Existence.

We have seen that a Proposition of Relation, beginning with "Some," asserts that some existing Things, being Members of its Subject, are also Members of its Predicate. Hence, it asserts that some existing Things are Members of both; i.e. it asserts that some existing Things are Members of the Class of Things which have all the Attributes of the Subject and the Predicate.

Hence, to translate it into a Proposition of Existence, we take "existing Things" as the new Subject, and Things, which have all the Attributes of the Subject and the Predicate, as the new Predicate.

Similarly for a Proposition of Relation beginning with "No".

A Proposition of Relation, beginning with "All", is (as shown in § 3) equivalent to two Propositions, one beginning with "Some" and the other with "No", each of which we now know how to translate.

[Let us work a few Examples, to illustrate these Rules.

(1)

"Some apples are not ripe."

Here we arrange thus:--

"Some"	<u>Sign of Quantity</u> .
"existing Things"	<u>Subject</u> .
"are"	<u>Copula</u> .
"not-ripe apples"	<u>Predicate</u> .

or thus:--

"Some | existing Things | are | not-ripe apples."

pg021

(2)

"Some farmers always grumble at the weather, whatever it may be."

Here we arrange thus:--

"Some | existing Things | are | farmers who always grumble at the weather, whatever it may be."

(3)

"No lambs are accustomed to smoke cigars."

Here we arrange thus:--

"No | existing Things | are | lambs accustomed to smoke cigars."

(4)

Symbolic Logic

"None of my speculations have brought me as much as 5 per cent."

Here we arrange thus:--

"No | existing Things | are | speculations of mine, which have brought me as much as 5 per cent."

(5)

"None but the brave deserve the fair."

Here we note, to begin with, that the phrase "none but the brave" is equivalent to "no not-brave men." We then arrange thus:--

"No | existing Things | are | not-brave men deserving of the fair."

(6)

"All bankers are rich men."

This is equivalent to the two Propositions "Some bankers are rich men" and "No bankers are poor men."

Here we arrange thus:--

"Some | existing Things | are | rich bankers";
and
"No | existing Things | are | poor bankers."]

[Work Examples § =1=, 1-4 (p. 97).]

pg022

BOOK III.

THE BILITERAL DIAGRAM.

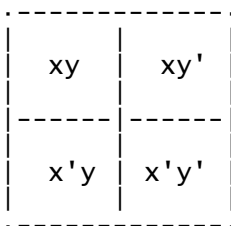

CHAPTER I.

SYMBOLS AND CELLS.

First, let us suppose that the above Diagram is an enclosure assigned to a certain Class of Things, which we have selected as our 'Universe of Discourse.' or, more briefly, as our 'Univ'.

[For example, we might say "Let Univ. be 'books'"; and we might imagine the Diagram to be a large table, assigned to all "books."]

Symbolic Logic

[The Reader is strongly advised, in reading this Chapter, not to refer to the above Diagram, but to draw a large one for himself, without any letters, and to have it by him while he reads, and keep his finger on that particular part of it, about which he is reading.]

pg023

Secondly, let us suppose that we have selected a certain Adjunct, which we may call "x," and have divided the large Class, to which we have assigned the whole Diagram, into the two smaller Classes whose Differentiæ are "x" and "not-x" (which we may call "x'"), and that we have assigned the North Half of the Diagram to the one (which we may call "the Class of x-Things," or "the x-Class"), and the South Half to the other (which we may call "the Class of x'-Things," or "the x'-Class").

[For example, we might say "Let x mean 'old,' so that x' will mean 'new'," and we might suppose that we had divided books into the two Classes whose Differentiæ are "old" and "new," and had assigned the North Half of the table to "old books" and the South Half to "new books."]

Thirdly, let us suppose that we have selected another Adjunct, which we may call "y", and have subdivided the x-Class into the two Classes whose Differentiæ are "y" and "y'", and that we have assigned the North-west Cell to the one (which we may call "the xy-Class"), and the North-east Cell to the other (which we may call "the xy'-Class").

[For example, we might say "Let y mean 'English,' so that y' will mean 'foreign'", and we might suppose that we had subdivided "old books" into the two Classes whose Differentiæ are "English" and "foreign", and had assigned the North-west Cell to "old English books", and the North-east Cell to "old foreign books."]

Fourthly, let us suppose that we have subdivided the x'-Class in the same manner, and have assigned the South-west Cell to the x'y-Class, and the South-east Cell to the x'y'-Class.

[For example, we might suppose that we had subdivided "new books" into the two Classes "new English books" and "new foreign books", and had assigned the South-west Cell to the one, and the South-east Cell to the other.]

It is evident that, if we had begun by dividing for y and y', and had then subdivided for x and x', we should have got the same four Classes. Hence we see that we have assigned the West Half to the y-Class, and the East Half to the y'-Class.

pg024

[Thus, in the above Example, we should find that we had assigned the West Half of the table to "English books" and the East Half to "foreign books."

old English books	old foreign books
new English books	new foreign books

We have, in fact, assigned the four Quarters of the table to four different Classes of books, as here shown.]

The Reader should carefully remember that, in such a phrase as "the x-Things," the word "Things" means that particular kind of Things, to which the whole Diagram has been assigned.

Symbolic Logic

[Thus, if we say "Let Univ. be 'books'," we mean that we have assigned the whole Diagram to "books." In that case, if we took "x" to mean "old", the phrase "the x-Things" would mean "the old books."]

The Reader should not go on to the next Chapter until he is quite familiar with the blank Diagram I have advised him to draw.

He ought to be able to name, instantly, the Adjunct assigned to any Compartment named in the right-hand column of the following Table.

Also he ought to be able to name, instantly, the Compartment assigned to any Adjunct named in the left-hand column.

To make sure of this, he had better put the book into the hands of some genial friend, while he himself has nothing but the blank Diagram, and get that genial friend to question him on this Table, dodging about as much as possible. The Questions and Answers should be something like this:--

pg025

TABLE I.

<u>Adjuncts</u> <u>of</u> <u>Classes.</u>	<u>Compartments, or Cells,</u> <u>assigned to them.</u>
x	North Half.
x'	South "
y	West "
y'	East "
xy	North-west Cell.
xy'	" East "
x'y	South-west "
x'y'	" East "

Q. "Adjunct for West Half?"

A. "y."

Q. "Compartment for xy'?"

A. "North-East Cell."

Q. "Adjunct for South-west Cell?"

A. "x'y."

&c., &c.

After a little practice, he will find himself able to do without the blank Diagram, and will be able to see it mentally ("in my mind's eye, Horatio!") while answering the questions of his genial friend. When this result has been reached, he may safely go on to the next Chapter.

pg026

CHAPTER II.

COUNTERS.

Let us agree that a Red Counter, placed within a Cell, shall mean "This Cell is occupied" (i.e. "There is at least one Thing in it").

Let us also agree that a Red Counter, placed on the partition between two Cells, shall mean "The Compartment, made up of these two Cells, is occupied; but it is not known whereabouts, in it, its occupants are." Hence it may be understood to mean "At least one of these two Cells is occupied: possibly both are."

Symbolic Logic

Our ingenious American cousins have invented a phrase to describe the condition of a man who has not yet made up his mind which of two political parties he will join: such a man is said to be "=sitting on the fence=" This phrase exactly describes the condition of the Red Counter.

Let us also agree that a Grey Counter, placed within a Cell, shall mean "This Cell is empty" (i.e. "There is nothing in it").

[The Reader had better provide himself with 4 Red Counters and 5 Grey ones.]

pg027

CHAPTER III.

REPRESENTATION OF PROPOSITIONS.

§ 1.

Introductory.

Henceforwards, in stating such Propositions as "Some x-Things exist" or "No x-Things are y-Things", I shall omit the word "Things", which the Reader can supply for himself, and shall write them as "Some x exist" or "No x are y".

[Note that the word "Things" is here used with a special meaning, as explained at p. 23.]

A Proposition, containing only one of the Letters used as Symbols for Attributes, is said to be 'Unilateral'.

[For example, "Some x exist", "No y' exist", &c.]

A Proposition, containing two Letters, is said to be 'Bilateral'.

[For example, "Some xy' exist", "No x' are y", &c.]

A Proposition is said to be 'in terms of' the Letters it contains, whether with or without accents.

[Thus, "Some xy' exist", "No x' are y", &c., are said to be in terms of x and y.]

pg028

§ 2.

Representation of Propositions of Existence.

Let us take, first, the Proposition "Some x exist".

[Note that this Proposition is (as explained at p. 12) equivalent to "Some existing Things are x-Things."]

This tells us that there is at least one Thing in the North Half; that is, that the North Half is occupied. And this we can evidently represent by placing a Red Counter (here represented by a dotted circle) on the partition which divides the North Half.

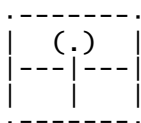

Symbolic Logic

[In the "books" example, this Proposition would be "Some old books exist".]

Similarly we may represent the three similar Propositions "Some x' exist", "Some y exist", and "Some y' exist".

[The Reader should make out all these for himself. In the "books" example, these Propositions would be "Some new books exist", &c.]

Let us take, next, the Proposition "No x exist".

This tells us that there is nothing in the North Half; that is, that the North Half is empty; that is, that the North-west Cell and the North-east Cell are both of them empty. And this we can represent by placing two Grey Counters in the North Half, one in each Cell.



[The Reader may perhaps think that it would be enough to place a Grey Counter on the partition in the North Half, and that, just as a Red Counter, so placed, would mean "This Half is occupied", so a Grey one would mean "This Half is empty".

This, however, would be a mistake. We have seen that a Red Counter, so placed, would mean "At least one of these two Cells is occupied: possibly both are." Hence a Grey one would merely mean "At least one of these two Cells is empty: possibly both are". But what we have to represent is, that both Cells are certainly empty: and this can only be done by placing a Grey Counter in each of them.

In the "books" example, this Proposition would be "No old books exist".]

pg029

Similarly we may represent the three similar Propositions "No x' exist", "No y exist", and "No y' exist".

[The Reader should make out all these for himself. In the "books" example, these three Propositions would be "No new books exist", &c.]

Let us take, next, the Proposition "Some xy exist".

This tells us that there is at least one Thing in the North-west Cell; that is, that the North-west Cell is occupied. And this we can represent by placing a Red Counter in it.

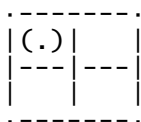

[In the "books" example, this Proposition would be "Some old English books exist".]

Similarly we may represent the three similar Propositions "Some xy' exist", "Some x'y exist", and "Some x'y' exist".

[The Reader should make out all these for himself. In the "books" example, these three Propositions would be "Some old foreign books exist", &c.]

Symbolic Logic

Let us take, next, the Proposition "No xy exist".

This tells us that there is nothing in the North-west Cell; that is, that the North-west Cell is empty. And this we can represent by placing a Grey Counter in it.

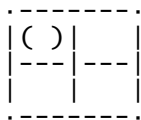

[In the "books" example, this Proposition would be "No old English books exist".]

Similarly we may represent the three similar Propositions "No xy' exist", "No x'y exist", and "No x'y' exist".

[The Reader should make out all these for himself. In the "books" example, these three Propositions would be "No old foreign books exist", &c.]

We have seen that the Proposition "No x exist" may be represented by placing two Grey Counters in the North Half, one in each Cell. pg030

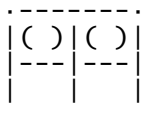

We have also seen that these two Grey Counters, taken separately, represent the two Propositions "No xy exist" and "No xy' exist".

Hence we see that the Proposition "No x exist" is a Double Proposition, and is equivalent to the two Propositions "No xy exist" and "No xy' exist".

[In the "books" example, this Proposition would be "No old books exist".]

Hence this is a Double Proposition, and is equivalent to the two Propositions "No old English books exist" and "No old foreign books exist".]

§ 3.

Representation of Propositions of Relation.

Let us take, first, the Proposition "Some x are y".

This tells us that at least one Thing, in the North Half, is also in the West Half. Hence it must be in the space common to them, that is, in the North-west Cell. Hence the North-west Cell is occupied. And this we can represent by placing a Red Counter in it.

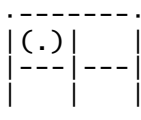

[Note that the Subject of the Proposition settles which Half we are to use; and that the Predicate settles in which portion of it we are to place the Red Counter.

In the "books" example, this Proposition would be "Some old

Symbolic Logic

books are English".]

Similarly we may represent the three similar Propositions "Some x are y'", "Some x' are y", and "Some x' are y'".

[The Reader should make out all these for himself. In the "books" example, these three Propositions would be "Some old books are foreign", &c.]

pg031

Let us take, next, the Proposition "Some y are x".

This tells us that at least one Thing, in the west Half, is also in the North Half. Hence it must be in the space common to them, that is, in the North-West Cell. Hence the North-West Cell is occupied. And this we can represent by placing a Red Counter in it.

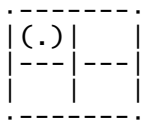

[In the "books" example, this Proposition would be "Some English books are old".]

Similarly we may represent the three similar Propositions "Some y are x'", "Some y' are x", and "Some y' are x'".

[The Reader should make out all these for himself. In the "books" example, these three Propositions would be "Some English books are new", &c.]

We see that this one Diagram has now served to represent no less than three Propositions, viz.

- (1) "Some xy exist;
- (2) Some x are y;
- (3) Some y are x".

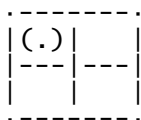

Hence these three Propositions are equivalent.

[In the "books" example, these Propositions would be

- (1) "Some old English books exist;
- (2) Some old books are English;
- (3) Some English books are old".]

The two equivalent Propositions, "Some x are y" and "Some y are x", are said to be '=Converse=' to each other; and the Process, of changing one into the other, is called '=Converting=', or '=Conversion='.

[For example, if we were told to convert the Proposition

"Some apples are not ripe,"

we should first choose our Univ. (say "fruit"), and then complete the Proposition, by supplying the Substantive "fruit" in the Predicate, so that it would be

"Some apples are not-ripe fruit";

and we should then convert it by interchanging its Terms, so

Symbolic Logic

that it would be

"Some not-ripe fruit are apples".]

pg032

Similarly we may represent the three similar Trios of equivalent Propositions; the whole Set of four Trios being as follows:--

- (1) "Some xy exist" = "Some x are y" = "Some y are x".
- (2) "Some xy' exist" = "Some x are y'" = "Some y' are x".
- (3) "Some x'y exist" = "Some x' are y" = "Some y are x'".
- (4) "Some x'y' exist" = "Some x' are y'" = "Some y' are x'".

Let us take, next, the Proposition "No x are y".

This tell us that no Thing, in the North Half, is also in the West Half. Hence there is nothing in the space common to them, that is, in the North-west Cell. Hence the North-west Cell is empty. And this we can represent by placing a Grey Counter in it.

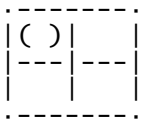

[In the "books" example, this Proposition would be "No old books are English".]

Similarly we may represent the three similar Propositions "No x are y'", and "No x' are y", and "No x' are y'".

[The Reader should make out all these for himself. In the "books" example, these three Propositions would be "No old books are foreign", &c.]

Let us take, next, the Proposition "No y are x".

This tells us that no Thing, in the West Half, is also in the North Half. Hence there is nothing in the space common to them, that is, in the North-west Cell. That is, the North-west Cell is empty. And this we can represent by placing a Grey Counter in it.

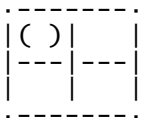

[In the "books" example, this Proposition would be "No English books are old".]

Similarly we may represent the three similar Propositions "No y are x'", "No y' are x", and "No y' are x'".

[The Reader should make out all these for himself. In the "books" example, these three Propositions would be "No English books are new", &c.]

pg033

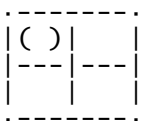

We see that this one Diagram has now served to present no less than three Propositions, viz.

- (1) "No xy exist;

Symbolic Logic

Some y exist	$(.)$	No y exist	$()$
Some y' exist	$(.)$	No y' exist	$()$

Similarly we may represent the seven similar Propositions "All x are y'", "All x' are y", "All x' are y'", "All y are x", "All y are x'", "All y' are x", and "All y' are x'".

Let us take, lastly, the Double Proposition "Some x are y and some are y'", each part of which we already know how to represent.

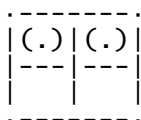

Similarly we may represent the three similar Propositions, "Some x' are y and some are y'", "Some y are x and some are x'", "Some y' are x and some are x'".

The Reader should now get his genial friend to question him, severely, on these two Tables. The Inquisitor should have the Tables before him: but the Victim should have nothing but a blank Diagram, and the Counters with which he is to represent the various Propositions named by his friend, e.g. "Some y exist", "No y' are x", "All x are y", &c. &c.

pg035

TABLE III.

Some xy exist = Some x are y = Some y are x	$(.)$	All x are y	$(.) ()$
Some xy' exist = Some x are y' = Some y' are x	$(.)$	All x are y'	$() (.)$
Some x'y exist = Some x' are y = Some y are x'	$(.)$	All x' are y	$(.) ()$
Some x'y' exist = Some x' are y' = Some y' are x'	$(.)$	All x' are y'	$() (.)$

No xy exist = No x are y	$()$	All y are x	$(.)$
-----------------------------	-------	-------------	-------

Symbolic Logic			
= No y are x			()
----- No xy' exist = No x are y' = No y' are x	()	All y are x'	() ()
----- No x'y exist = No x' are y' = No y are x'	()	All y' are x	() ()
----- No x'y' exist = No x' are y' = No y' are x'	()	All y' are x'	() ()

Some x are y, and some are y'	(.) (.)	Some y are x and some are x'	(.) (.)
----- Some x' are y, and some are y'	(.) (.)	Some y' are x and some are x'	(.) (.)

pg036

CHAPTER IV.

INTERPRETATION OF BILITERAL DIAGRAM WHEN MARKED WITH COUNTERS.

The Diagram is supposed to be set before us, with certain Counters placed upon it; and the problem is to find out what Proposition, or Propositions, the Counters represent.

As the process is simply the reverse of that discussed in the previous Chapter, we can avail ourselves of the results there obtained, as far as they go.

First, let us suppose that we find a Red Counter placed in the North-West Cell.

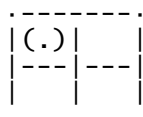

We know that this represents each of the Trio of equivalent Propositions

"Some xy exist" = "Some x are y" = "Some y are x".

Similarly we may interpret a Red Counter, when placed in the North-East, or South-West, or South-East Cell.

Next, let us suppose that we find a Grey Counter placed in the

Symbolic Logic

North-West Cell.

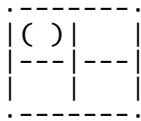

We know that this represents each of the Trio of equivalent Propositions "No xy exist" = "No x are y" = "No y are x".

Similarly we may interpret a Grey Counter, when placed in the North-East, or South-West, or South-East Cell.

pg037

Next, let us suppose that we find a Red Counter placed on the partition which divides the North Half.

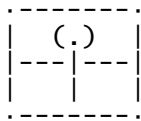

We know that this represents the Proposition "Some x exist."

Similarly we may interpret a Red Counter, when placed on the partition which divides the South, or West, or East Half.

* * * * *

Next, let us suppose that we find two Red Counters placed in the North Half, one in each Cell.

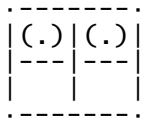

We know that this represents the Double Proposition "Some x are y and some are y'".

Similarly we may interpret two Red Counters, when placed in the South, or West, or East Half.

* * * * *

Next, let us suppose that we find two Grey Counters placed in the North Half, one in each Cell.



We know that this represents the Proposition "No x exist".

Similarly we may interpret two Grey Counters, when placed in the South, or West, or East Half.

* * * * *

Lastly, let us suppose that we find a Red and a Grey Counter placed in the North Half, the Red in the North-west Cell, and the Grey in the North-East Cell.

Symbolic Logic

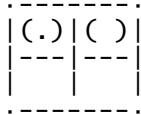

We know that this represents the Proposition, "All x are y".

[Note that the Half, occupied by the two Counters, settles what is to be the Subject of the Proposition, and that the Cell, occupied by the Red Counter, settles what is to be its Predicate.]

pg038

Similarly we may interpret a Red and a Grey counter, when placed in any one of the seven similar positions

- Red in North-East, Grey in North-West;
- Red in South-West, Grey in South-East;
- Red in South-East, Grey in South-West;
- Red in North-West, Grey in South-West;
- Red in South-West, Grey in North-West;
- Red in North-East, Grey in South-East;
- Red in South-East, Grey in North-East.

Once more the genial friend must be appealed to, and requested to examine the Reader on Tables II and III, and to make him not only represent Propositions, but also interpret Diagrams when marked with Counters.

The Questions and Answers should be like this:--

- Q. Represent "No x' are y'."
- A. Grey Counter in S.E. Cell.
- Q. Interpret Red Counter on E. partition.
- A. "Some y' exist."
- Q. Represent "All y' are x."
- A. Red in N.E. Cell; Grey in S.E.
- Q. Interpret Grey Counter in S.W. Cell.
- A. "No x'y exist" = "No x' are y" = "No y are x'".
&c., &c.

At first the Examinee will need to have the Board and Counters before him; but he will soon learn to dispense with these, and to answer with his eyes shut or gazing into vacancy.

[Work Examples § =1=, 5-8 (p. 97).]

pg039

BOOK IV.

THE TRILITERAL DIAGRAM.

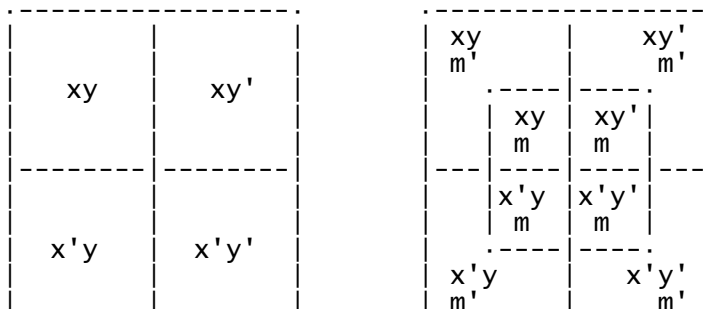

CHAPTER I.

SYMBOLS AND CELLS.

First, let us suppose that the above left-hand Diagram is the Biliteral Diagram that we have been using in Book III., and that we change it into a Triliteral Diagram by drawing an Inner Square, so as to divide each of its 4 Cells into 2 portions, thus making 8 Cells altogether. The right-hand Diagram shows the result.

[The Reader is strongly advised, in reading this Chapter, not to refer to the above Diagrams, but to make a large copy of the right-hand one for himself, without any letters, and to have it by him while he reads, and keep his finger on that particular part of it, about which he is reading.]

Secondly, let us suppose that we have selected a certain Adjunct, which we may call "m", and have subdivided the xy-Class into the two Classes whose Differentiæ are m and m', and that we have assigned the N.W. Inner Cell to the one (which we may call "the Class of xym-Things", or "the xym-Class"), and the N.W. Outer Cell to the other (which we may call "the Class of xym'-Things", or "the xym'-Class").

pg040

[Thus, in the "books" example, we might say "Let m mean 'bound', so that m' will mean 'unbound'", and we might suppose that we had subdivided the Class "old English books" into the two Classes, "old English bound books" and "old English unbound books", and had assigned the N.W. Inner Cell to the one, and the N.W. Outer Cell to the other.]

Thirdly, let us suppose that we have subdivided the xy'-Class, the x'y-Class, and the x'y'-Class in the same manner, and have, in each case, assigned the Inner Cell to the Class possessing the Attribute m, and the Outer Cell to the Class possessing the Attribute m'.

[Thus, in the "books" example, we might suppose that we had subdivided the "new English books" into the two Classes, "new English bound books" and "new English unbound books", and had assigned the S.W. Inner Cell to the one, and the S.W. Outer Cell to the other.]

It is evident that we have now assigned the Inner Square to the m-Class, and the Outer Border to the m'-Class.

[Thus, in the "books" example, we have assigned the Inner Square to "bound books" and the Outer Border to "unbound books".]

When the Reader has made himself familiar with this Diagram, he ought to be able to find, in a moment, the Compartment assigned to a particular pair of Attributes, or the Cell assigned to a particular trio of Attributes. The following Rules will help him in doing this:--

- (1) Arrange the Attributes in the order x, y, m.
- (2) Take the first of them and find the Compartment assigned to it.
- (3) Then take the second, and find what portion of that compartment is assigned to it.
- (4) Treat the third, if there is one, in the same way.

pg041

Symbolic Logic

[For example, suppose we have to find the Compartment assigned to ym . We say to ourselves "y has the West Half; and m has the Inner portion of that west Half."

Again, suppose we have to find the Cell assigned to $x'ym'$. We say to ourselves "x' has the South Half; y has the West portion of that South Half, i.e. has the South-west Quarter; and m' has the Outer portion of that South-west Quarter."]

The Reader should now get his genial friend to question him on the Table given on the next page, in the style of the following specimen-Dialogue.

- Q. Adjunct for South Half, Inner Portion?
- A. $x'm$.
- Q. Compartment for m' ?
- A. The Outer Border.
- Q. Adjunct for North-East Quarter, Outer Portion?
- A. $xy'm'$.
- Q. Compartment for ym ?
- A. West Half, Inner Portion.
- Q. Adjunct for South Half?
- A. x' .
- Q. Compartment for $x'y'm'$?
- A. South-East Quarter, Inner Portion.
&c. &c.

pg042

TABLE IV.

Adjunct of Classes.	Compartments, or Cells, assigned to them.
x	North Half.
x'	South "
y	West "
y'	East "
m	Inner Square.
m'	Outer Border.
xy	North-West Quarter.
xy'	" East "
$x'y$	South-West "
$x'y'$	" East "
xm	North Half, Inner Portion.
xm'	" " Outer "
$x'm$	South " Inner "
$x'm'$	" " Outer "
ym	West " Inner "
ym'	" " Outer "
$y'm$	East " Inner "
$y'm'$	" " Outer "
xym	North-West Quarter, Inner Portion.
xym'	" " " Outer "
$xy'm$	" East " Inner "
$xy'm'$	" " " Outer "
$x'ym$	South-West " Inner "
$x'ym'$	" " " Outer "
$x'y'm$	" East " Inner "
$x'y'm'$	" " " Outer "

pg043

Symbolic Logic

REPRESENTATION OF PROPOSITIONS IN TERMS OF x AND m, OR OF y AND m.

§ 1.

Representation of Propositions of Existence in terms of x and m, or of y and m.

Let us take, first, the Proposition "Some xm exist".

[Note that the full meaning of this Proposition is (as explained at p. 12) "Some existing Things are xm-Things".]

This tells us that there is at least one Thing in the Inner portion of the North Half; that is, that this Compartment is occupied. And this we can evidently represent by placing a Red Counter on the partition which divides it.

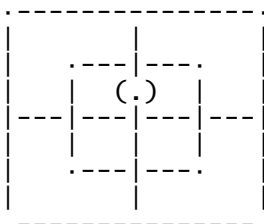

[In the "books" example, this Proposition would mean "Some old bound books exist" (or "There are some old bound books").]

Similarly we may represent the seven similar Propositions, "Some xm' exist", "Some x'm exist", "Some x'm' exist", "Some ym exist", "Some ym' exist", "Some y'm exist", and "Some y'm' exist".

pg044

Let us take, next, the Proposition "No xm exist".

This tells us that there is nothing in the Inner portion of the North Half; that is, that this Compartment is empty. And this we can represent by placing two Grey Counters in it, one in each Cell.

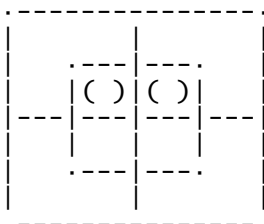

Similarly we may represent the seven similar Propositions, in terms of x and m, or of y and m, viz. "No xm' exist", "No x'm exist", &c.

* * * * *

These sixteen Propositions of Existence are the only ones that we shall have to represent on this Diagram.

§ 2.

Representation of Propositions of Relation in terms of x and m, or of y and m.

Let us take, first, the Pair of Converse Propositions

"Some x are m" = "Some m are x."

Symbolic Logic

We know that each of these is equivalent to the Proposition of Existence "Some xm exist", which we already know how to represent.

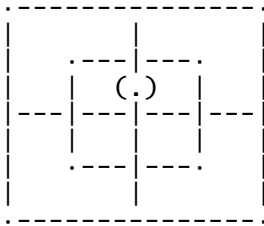

Similarly for the seven similar Pairs, in terms of x and m, or of y and m.

Let us take, next, the Pair of Converse Propositions

"No x are m" = "No m are x."

We know that each of these is equivalent to the Proposition of Existence "No xm exist", which we already know how to represent.

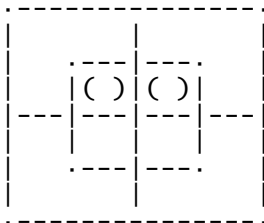

Similarly for the seven similar Pairs, in terms of x and m, or of y and m.

pg045

Let us take, next, the Proposition "All x are m."

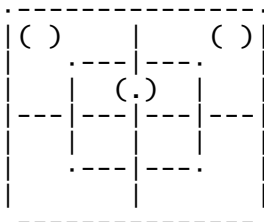

We know (see p. 18) that this is a Double Proposition, and equivalent to the two Propositions "Some x are m" and "No x are m' ", each of which we already know how to represent.

Similarly for the fifteen similar Propositions, in terms of x and m, or of y and m.

These thirty-two Propositions of Relation are the only ones that we shall have to represent on this Diagram.

The Reader should now get his genial friend to question him on the following four Tables.

The Victim should have nothing before him but a blank Triliteral Diagram, a Red Counter, and 2 Grey ones, with which he is to represent the various Propositions named by the Inquisitor, e.g. "No y' are m", "Some xm' exist", &c., &c.

pg046

Symbolic Logic

	<p>Some xm exist = Some x are m = Some m are x</p>	
	<p>Some xm' exist = Some x are m' = Some m' are x</p>	
	<p>Some x'm exist = Some x' are m = Some m are x'</p>	
	<p>Some x'm' exist = Some x' are m' = Some m' are x'</p>	

TABLE VI.

pg047

	<p>Some ym exist = Some y are m = Some m are y</p>	
	<p>Some ym' exist = Some y are m' = Some m' are y</p>	
	<p>Some y'm exist = Some y' are m</p>	

Symbolic Logic		
	= Some m are y' No y'm exist = No y' are m = No m are y'	
	Some y'm' exist = Some y' are m' = Some m' are y' No y'm' exist = No y' are m' = No m' are y'	

TABLE VII.

pg048

	All x are m All x are m'	
	All x' are m All x' are m'	
	All m are x All m are x'	
	All m' are x All m' are x'	

TABLE VIII.

pg049

	All y are m	
--	-------------	--

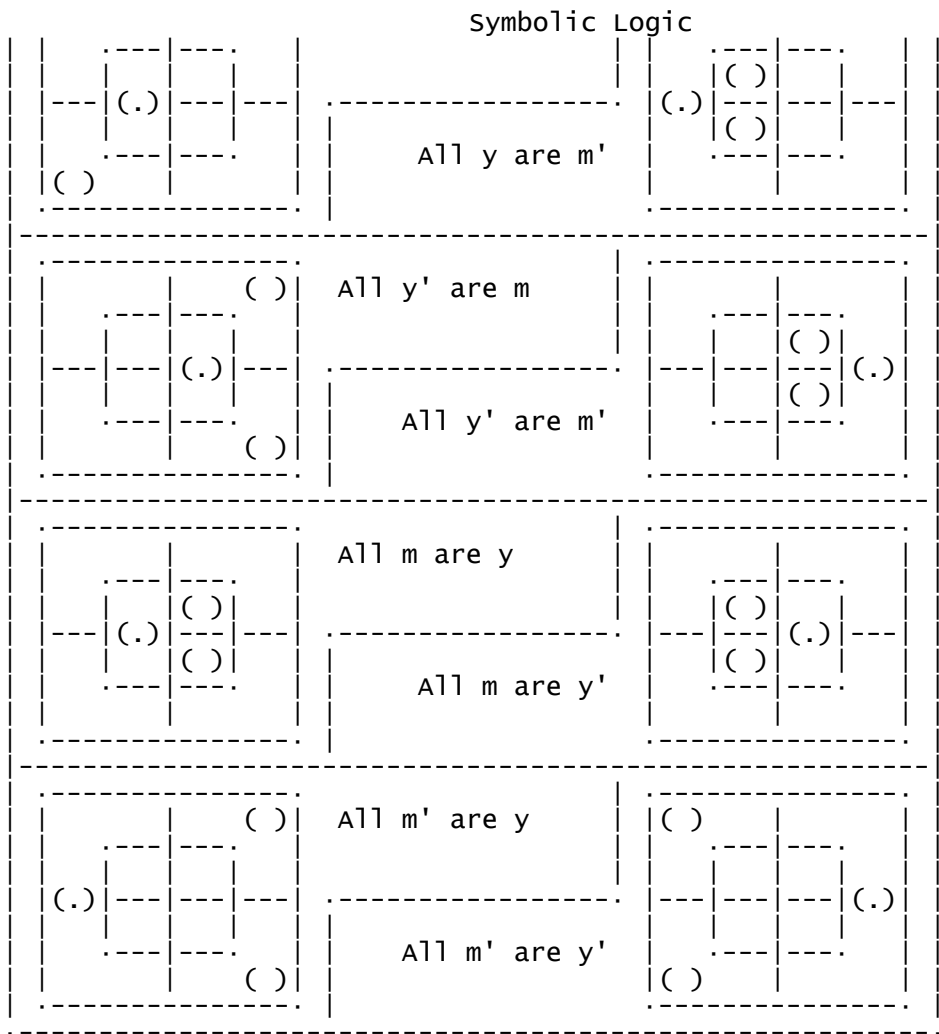

pg050

CHAPTER III.

REPRESENTATION OF TWO PROPOSITIONS OF RELATION, ONE IN TERMS OF x AND m, AND THE OTHER IN TERMS OF y AND m, ON THE SAME DIAGRAM.

The Reader had better now begin to draw little Diagrams for himself, and to mark them with the Digits "1" and "0", instead of using the Board and Counters: he may put a "1" to represent a Red Counter (this may be interpreted to mean "There is at least one Thing here"), and a "0" to represent a Grey Counter (this may be interpreted to mean "There is nothing here").

The Pair of Propositions, that we shall have to represent, will always be, one in terms of x and m, and the other in terms of y and m.

When we have to represent a Proposition beginning with "All", we break it up into the two Propositions to which it is equivalent.

When we have to represent, on the same Diagram, Propositions, of which some begin with "Some" and others with "No", we represent the negative ones first. This will sometimes save us from having to put a "1" "on a fence" and afterwards having to shift it into a Cell.

[Let us work a few examples.

(1)

Symbolic Logic

"No x are m';
No y' are m".

Let us first represent "No x are m'". This gives us Diagram a.

Then, representing "No y' are m" on the same Diagram, we get Diagram b.

pg051

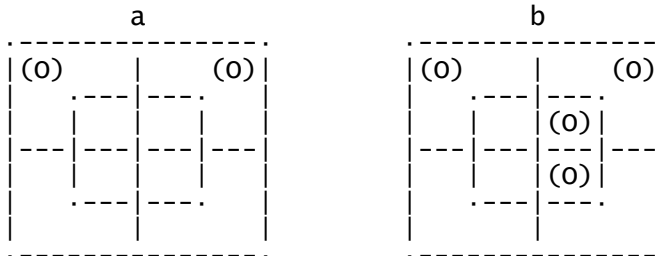

(2)

"Some m are x;
No m are y".

If, neglecting the Rule, we were begin with "Some m are x", we should get Diagram a.

And if we were then to take "No m are y", which tells us that the Inner N.W. Cell is empty, we should be obliged to take the "I" off the fence (as it no longer has the choice of two Cells), and to put it into the Inner N.E. Cell, as in Diagram c.

This trouble may be saved by beginning with "No m are y", as in Diagram b.

And now, when we take "Some m are x", there is no fence to sit on! The "I" has to go, at once, into the N.E. Cell, as in Diagram c.

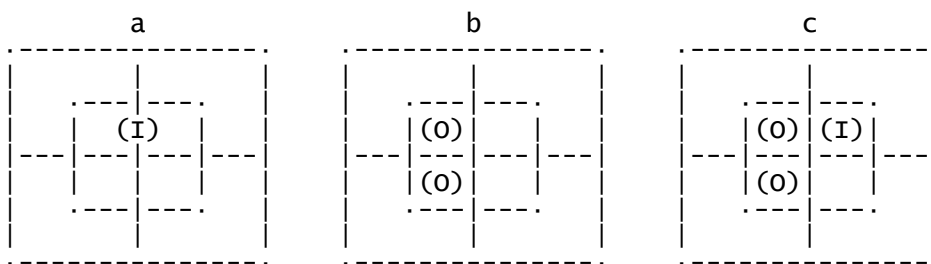

(3)

"No x' are m';
All m are y".

Here we begin by breaking up the second into the two Propositions to which it is equivalent. Thus we have three Propositions to represent, viz.--

- (1) "No x' are m';
- (2) Some m are y;
- (3) No m are y'".

These we will take in the order 1, 3, 2.

First we take No. (1), viz. "No x' are m'". This gives us Diagram a.

Adding to this, No. (3), viz. "No m are y'", we get Diagram b.

This time the "I", representing No. (2), viz. "Some m are y," has to sit on the fence, as there is no "O" to order it off! This gives us Diagram c.

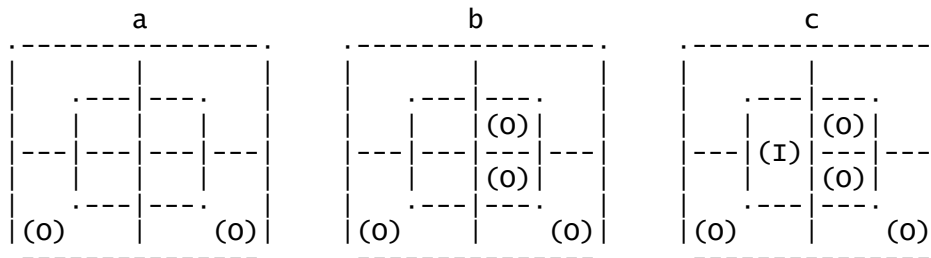

(4)

"All m are x;
All y are m".

Here we break up both Propositions, and thus get four to represent, viz.--

- (1) "Some m are x;
- (2) No m are x'";
- (3) Some y are m;
- (4) No y are m'".

These we will take in the order 2, 4, 1, 3.

First we take No. (2), viz. "No m are x'". This gives us Diagram a.

To this we add No. (4), viz. "No y are m'", and thus get Diagram b.

If we were to add to this No. (1), viz. "Some m are x", we should have to put the "I" on a fence: so let us try No. (3) instead, viz. "Some y are m". This gives us Diagram c.

And now there is no need to trouble about No. (1), as it would not add anything to our information to put a "I" on the fence. The Diagram already tells us that "Some m are x".]

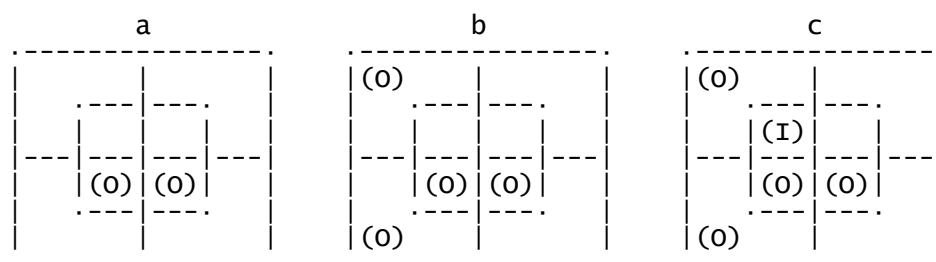

[Work Examples § =1=, 9-12 (p. 97); § =2=, 1-20 (p. 98).]

CHAPTER IV.

INTERPRETATION, IN TERMS OF x AND y, OF TRILITERAL DIAGRAM, WHEN MARKED WITH COUNTERS OR DIGITS.

Symbolic Logic

The problem before us is, given a marked Trilateral Diagram, to ascertain what Propositions of Relation, in terms of x and y, are represented on it.

The best plan, for a beginner, is to draw a Bilateral Diagram alongside of it, and to transfer, from the one to the other, all the information he can. He can then read off, from the Biliteral Diagram, the required Propositions. After a little practice, he will be able to dispense with the Biliteral Diagram, and to read off the result from the Trilateral Diagram itself.

To transfer the information, observe the following Rules:--

- (1) Examine the N.W. Quarter of the Trilateral Diagram.
- (2) If it contains a "I", in either Cell, it is certainly occupied, and you may mark the N.W. Quarter of the Biliteral Diagram with a "I".
- (3) If it contains two "O"s, one in each cell, it is certainly empty, and you may mark the N.W. Quarter of the Biliteral Diagram with a "O".
- (4) Deal in the same way with the N.E., the S.W., and the S.E. Quarter.

pg054

[Let us take, as examples, the results of the four Examples worked in the previous Chapters.

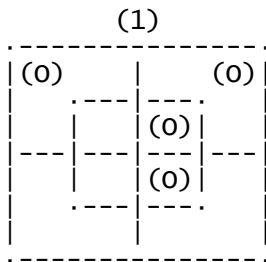

In the N.W. Quarter, only one of the two Cells is marked as empty: so we do not know whether the N.W. Quarter of the Biliteral Diagram is occupied or empty: so we cannot mark it.

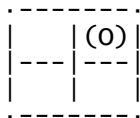

In the N.E. Quarter, we find two "O"s: so this Quarter is certainly empty; and we mark it so on the Biliteral Diagram.

In the S.W. Quarter, we have no information at all.

In the S.E. Quarter, we have not enough to use.

We may read off the result as "No x are y'", or "No y' are x," whichever we prefer.

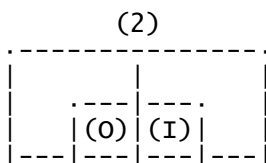

Symbolic Logic

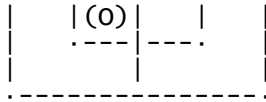

In the N.W. Quarter, we have not enough information to use.

In the N.E. Quarter, we find a "I". This shows us that it is occupied: so we may mark the N.E. Quarter on the Biliteral Diagram with a "I".

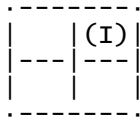

In the S.W. Quarter, we have not enough information to use.

In the S.E. Quarter, we have none at all.

We may read off the result as "Some x are y'", or "Some y' are x", whichever we prefer.

pg055

(3)

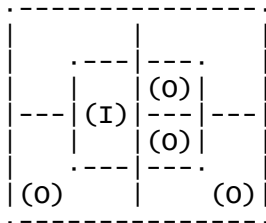

In the N.W. Quarter, we have no information. (The "I", sitting on the fence, is of no use to us until we know on which side he means to jump down!)

In the N.E. Quarter, we have not enough information to use.

Neither have we in the S.W. Quarter.

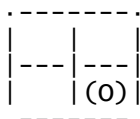

The S.E. Quarter is the only one that yields enough information to use. It is certainly empty: so we mark it as such on the Biliteral Diagram.

We may read off the results as "No x' are y'", or "No y' are x'", whichever we prefer.

(4)

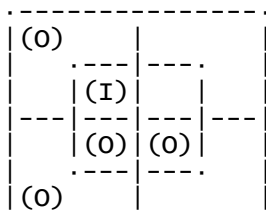

The N.W. Quarter is occupied, in spite of the "O" in the Outer

Symbolic Logic

Cell. So we mark it with a "I" on the Biliteral Diagram.

The N.E. Quarter yields no information.

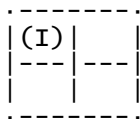

The S.W. Quarter is certainly empty. So we mark it as such on the Biliteral Diagram.

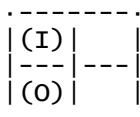

The S.E. Quarter does not yield enough information to use.

We read off the result as "All y are x."]

[Review Tables V, VI (pp. 46, 47). work Examples § =1=, 13-16 (p. 97); § =2=, 21-32 (p. 98); § =3=, 1-20 (p. 99).]

pg056

BOOK V.

SYLLOGISMS.

CHAPTER I.

INTRODUCTORY

When a Trio of Biliteral Propositions of Relation is such that

- (1) all their six Terms are Species of the same Genus,
- (2) every two of them contain between them a Pair of codivisional Classes,
- (3) the three Propositions are so related that, if the first two were true, the third would be true,

the Trio is called a '=Syllogism='; the Genus, of which each of the six Terms is a Species, is called its '=Universe of Discourse=', or, more briefly, its '=Univ.='; the first two Propositions are called its '=Premisses=', and the third its '=Conclusion='; also the Pair of codivisional Terms in the Premisses are called its '=Eliminands=', and the other two its '=Retinends='.

The Conclusion of a syllogism is said to be '=consequent=' from its Premisses: hence it is usual to prefix to it the word "Therefore" (or the symbol ".'.").

pg057

[Note that the 'Eliminands' are so called because they are eliminated, and do not appear in the Conclusion; and that the 'Retinends' are so called because they are retained, and do appear in the Conclusion.

Note also that the question, whether the Conclusion is or is not

Symbolic Logic

consequent from the Premisses, is not affected by the _actual_ truth or falsity of any of the Trio, but depends entirely on their _relationship_ to each other_.

As a specimen-Syllogism, let us take the Trio

"No x-Things are m-Things;
No y-Things are m'-Things.
No x-Things are y-Things."

which we may write, as explained at p. 26, thus:--

"No x are m;
No y are m'.
No x are y".

Here the first and second contain the Pair of codivisional Classes m and m'; the first and third contain the Pair x and x; and the second and third contain the Pair y and y.

Also the three Propositions are (as we shall see hereafter) so related that, if the first two were true, the third would also be true.

Hence the Trio is a _Syllogism_; the two Propositions, "No x are m" and "No y are m'", are its _Premisses_; the Proposition "No x are y" is its _Conclusion_; the Terms m and m' are its _Eliminands_; and the Terms x and y are its _Retinends_.

Hence we may write it thus:--

"No x are m;
No y are m'.
.'. No x are y".

As a second specimen, let us take the Trio

"All cats understand French;
Some chickens are cats.
Some chickens understand French".

These, put into normal form, are

"All cats are creatures understanding French;
Some chickens are cats.
Some chickens are creatures understanding French".

Here all the six Terms are Species of the Genus "creatures."

Also the first and second Propositions contain the Pair of codivisional Classes "cats" and "cats"; the first and third contain the Pair "creatures understanding French" and "creatures understanding French"; and the second and third contain the Pair "chickens" and "chickens".

pg058

Also the three Propositions are (as we shall see at p. 64) so related that, if the first two were true, the third would be true. (The first two are, as it happens, _not_ strictly true in _our_ planet. But there is nothing to hinder them from being true in some _other_ planet, say _Mars_ or _Jupiter_--in which case the third would _also_ be true in that planet, and its inhabitants would probably engage chickens as nursery-governesses. They would thus secure a singular _contingent_ privilege, unknown in England, namely, that they would be able, at any time when provisions ran short, to utilise the nursery-governess for the nursery-dinner!)

Hence the Trio is a _Syllogism_; the Genus "creatures" is its

Symbolic Logic

'Univ. '; the two Propositions, "All cats understand French" and "Some chickens are cats", are its Premises, the Proposition "Some chickens understand French" is its Conclusion; the Terms "cats" and "chickens" are its Eliminands; and the Terms, "creatures understanding French" and "chickens", are its Retinends.

Hence we may write it thus:--

"All cats understand French;
Some chickens are cats;
.'. Some chickens understand French".]

pg059

CHAPTER II.

PROBLEMS IN SYLLOGISMS.

§ 1.

Introductory.

When the Terms of a Proposition are represented by words, it is said to be '=concrete='; when by letters, '=abstract='.

To translate a Proposition from concrete into abstract form, we fix on a Univ., and regard each Term as a Species of it, and we choose a letter to represent its Differentia.

[For example, suppose we wish to translate "Some soldiers are brave" into abstract form. We may take "men" as Univ., and regard "soldiers" and "brave men" as Species of the Genus "men"; and we may choose x to represent the peculiar Attribute (say "military") of "soldiers," and y to represent "brave." Then the Proposition may be written "Some military men are brave men"; i.e. "Some x-men are y-men"; i.e. (omitting "men," as explained at p. 26) "Some x are y."

In practice, we should merely say "Let Univ. be "men", x = soldiers, y = brave", and at once translate "Some soldiers are brave" into "Some x are y."]

The Problems we shall have to solve are of two kinds, viz.

(1) "Given a Pair of Propositions of Relation, which contain between them a pair of codivisional Classes, and which are proposed as Premises: to ascertain what Conclusion, if any, is consequent from them."

(2) "Given a Trio of Propositions of Relation, of which every two contain a pair of codivisional Classes, and which are proposed as a Syllogism: to ascertain whether the proposed Conclusion is consequent from the proposed Premises, and, if so, whether it is complete."

These Problems we will discuss separately.

pg060

§ 2.

Given a Pair of Propositions of Relation, which contain between them a pair of codivisional Classes, and which are proposed as Premises: to ascertain what Conclusion, if any, is consequent from them.

The Rules, for doing this, are as follows:--

(1) Determine the 'Universe of Discourse'.

Symbolic Logic

- (2) Construct a Dictionary, making m and m' (or m and m') represent the pair of codivisional Classes, and x (or x') and y (or y') the other two.
- (3) Translate the proposed Premisses into abstract form.
- (4) Represent them, together, on a Trilateral Diagram.
- (5) Ascertain what Proposition, if any, in terms of x and y, is also represented on it.
- (6) Translate this into concrete form.

It is evident that, if the proposed Premisses were true, this other Proposition would also be true. Hence it is a Conclusion consequent from the proposed Premisses.

[Let us work some examples.

(1)

"No son of mine is dishonest;
People always treat an honest man with respect".

Taking "men" as Univ., we may write these as follows:--

"No sons of mine are dishonest men;
All honest men are men treated with respect".

We can now construct our Dictionary, viz. m = honest; x = sons of mine; y = treated with respect.

(Note that the expression "x = sons of mine" is an abbreviated form of "x = the Differentia of 'sons of mine', when regarded as a Species of 'men'".)

The next thing is to translate the proposed Premisses into abstract form, as follows:--

"No x are m';
All m are y".

Next, by the process described at p. 50, we represent these on a Trilateral Diagram, thus:--

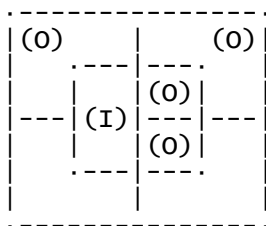

Next, by the process described at p. 53, we transfer to a Biliteral Diagram all the information we can.

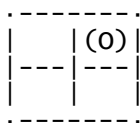

The result we read as "No x are y'" or as "No y' are x," whichever we prefer. So we refer to our Dictionary, to see which will look best; and we choose

Symbolic Logic

"No x are y",

which, translated into concrete form, is

"No son of mine fails to be treated with respect".

(2)

"All cats understand French;
Some chickens are cats".

Taking "creatures" as Univ., we write these as follows:--

"All cats are creatures understanding French;
Some chickens are cats".

We can now construct our Dictionary, viz. m = cats;
x = understanding French; y = chickens.

The proposed Premisses, translated into abstract form, are

"All m are x;
Some y are m".

In order to represent these on a Trilateral Diagram, we break up the first into the two Propositions to which it is equivalent, and thus get the three Propositions

- (1) "Some m are x;
- (2) No m are x'";
- (3) Some y are m".

The Rule, given at p. 50, would make us take these in the order 2, 1, 3.

This, however, would produce the result

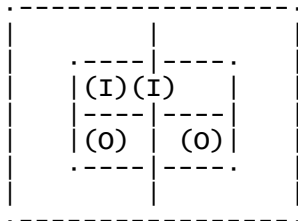

pg062

So it would be better to take them in the order 2, 3, 1. Nos. (2) and (3) give us the result here shown; and now we need not trouble about No. (1), as the Proposition "Some m are x" is already represented on the Diagram.

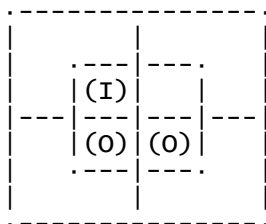

Transferring our information to a Biliteral Diagram, we get

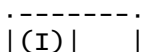

Symbolic Logic

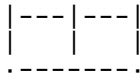

This result we can read either as "Some x are y" or "Some y are x".

After consulting our Dictionary, we choose

"Some y are x",

which, translated into concrete form, is

"Some chickens understand French."

(3)

"All diligent students are successful;
All ignorant students are unsuccessful".

Let Univ. be "students"; m = successful; x = diligent;
y = ignorant.

These Premisses, in abstract form, are

"All x are m;
All y are m'".

These, broken up, give us the four Propositions

- (1) "Some x are m;
- (2) No x are m' ;
- (3) Some y are m' ;
- (4) No y are m".

which we will take in the order 2, 4, 1, 3.

Representing these on a Trilateral Diagram, we get

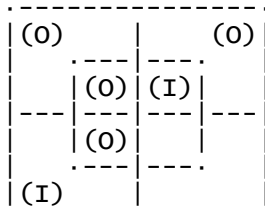

And this information, transferred to a Biliteral Diagram, is

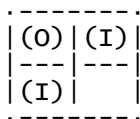

Here we get two Conclusions, viz.

"All x are y' ;
All y are x' ."

And these, translated into concrete form, are

"All diligent students are (not-ignorant, i.e.) learned;
All ignorant students are (not-diligent, i.e.) idle".
(See p. 4.)

pg063

Symbolic Logic

(4)

"Of the prisoners who were put on their trial at the last Assizes, all, against whom the verdict 'guilty' was returned, were sentenced to imprisonment; Some, who were sentenced to imprisonment, were also sentenced to hard labour".

Let Univ. be "the prisoners who were put on their trial at the last Assizes"; m = who were sentenced to imprisonment; x = against whom the verdict 'guilty' was returned; y = who were sentenced to hard labour.

The Premisses, translated into abstract form, are

"All x are m;
Some m are y".

Breaking up the first, we get the three

- (1) "Some x are m;
- (2) No x are m';
- (3) Some m are y".

Representing these, in the order 2, 1, 3, on a Trilateral Diagram, we get

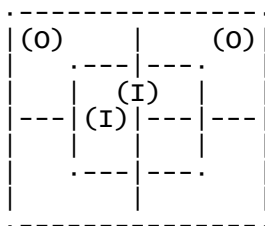

Here we get no Conclusion at all.

You would very likely have guessed, if you had seen only the Premisses, that the Conclusion would be

"Some, against whom the verdict 'guilty' was returned, were sentenced to hard labour".

But this Conclusion is not even true, with regard to the Assizes I have here invented.

"Not true!" you exclaim. "Then who were they, who were sentenced to imprisonment and were also sentenced to hard labour? They must have had the verdict 'guilty' returned against them, or how could they be sentenced?"

Well, it happened like this, you see. They were three ruffians, who had committed highway-robbery. When they were put on their trial, they pleaded 'guilty'. So no verdict was returned at all; and they were sentenced at once.]

I will now work out, in their briefest form, as models for the Reader to imitate in working examples, the above four concrete Problems.

pg064

(1) [see p. 60]

"No son of mine is dishonest;
People always treat an honest man with respect."

Univ. "men"; m = honest; x = my sons; y = treated with respect.

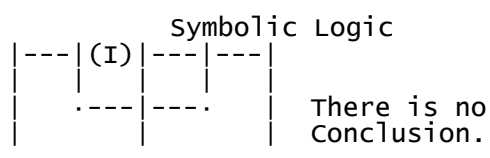

[Review Tables VII, VIII (pp. 48, 49). work Examples § =1=, 17-21 (p. 97); § =4=, 1-6 (p. 100); § =5=, 1-6 (p. 101).]

pg066

§ 3.

Given a Trio of Propositions of Relation, of which every two contain a Pair of codivisional Classes, and which are proposed as a Syllogism; to ascertain whether the proposed Conclusion is consequent from the proposed Premisses, and, if so, whether it is complete.

The Rules, for doing this, are as follows:--

- (1) Take the proposed Premisses, and ascertain, by the process described at p. 60, what Conclusion, if any, is consequent from them.
- (2) If there be no Conclusion, say so.
- (3) If there be a Conclusion, compare it with the proposed Conclusion, and pronounce accordingly.

I will now work out, in their briefest form, as models for the Reader to imitate in working examples, six Problems.

(1)

"All soldiers are strong;
All soldiers are brave.
Some strong men are brave."

Univ. "men"; m = soldiers; x = strong; y = brave.

pg067

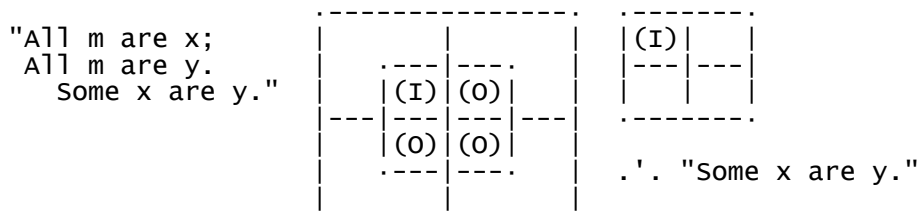

Hence proposed Conclusion is right.

(2)

"I admire these pictures;
When I admire anything I wish to examine it thoroughly.
I wish to examine some of these pictures thoroughly."

Univ. "things"; m = admired by me; x = these pictures; y = things which I wish to examine thoroughly.

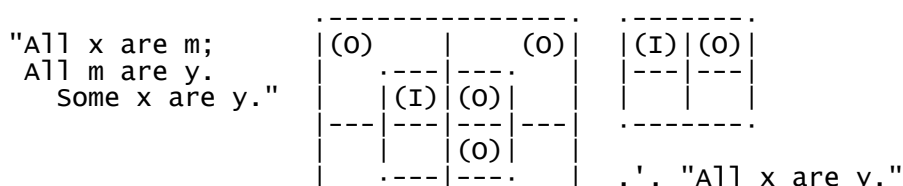

Symbolic Logic



Hence proposed Conclusion is incomplete, the complete one being "I wish to examine all these pictures thoroughly".

(3)

"None but the brave deserve the fair;
Some braggarts are cowards.
Some braggarts do not deserve the fair."

Univ. "persons"; m = brave; x = deserving of the fair; y = braggarts.

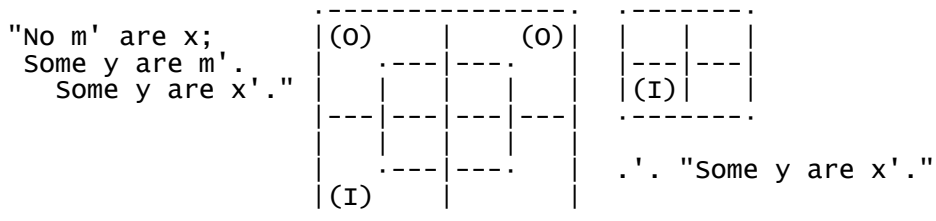

Hence proposed Conclusion is right.

pg068

(4)

"All soldiers can march;
Some babies are not soldiers.
Some babies cannot march".

Univ. "persons"; m = soldiers; x = able to march; y = babies.

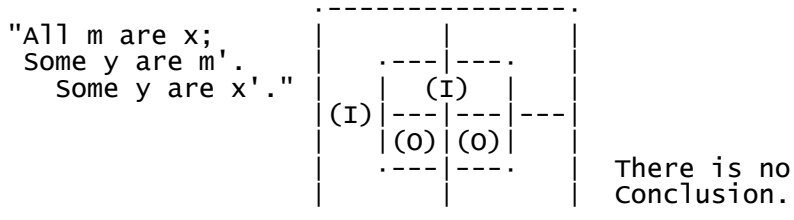

(5)

"All selfish men are unpopular;
All obliging men are popular.
All obliging men are unselfish".

Univ. "men"; m = popular; x = selfish; y = obliging.

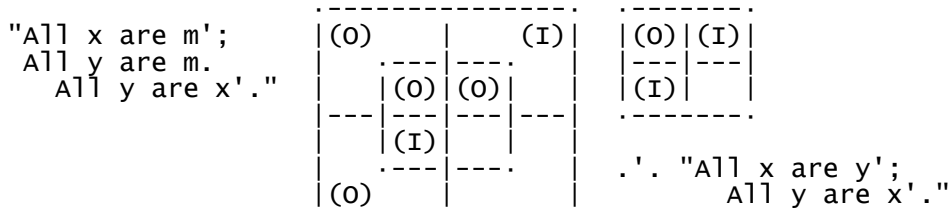

Hence proposed Conclusion is incomplete, the complete one containing, in addition, "All selfish men are disobliging".

(6)

"No one, who means to go by the train and cannot get a

Symbolic Logic

conveyance, and has not enough time to walk to the station, can do without running;

This party of tourists mean to go by the train and cannot get a conveyance, but they have plenty of time to walk to the station.

This party of tourists need not run."

Univ. "persons meaning to go by the train, and unable to get a conveyance"; m = having enough time to walk to the station; x = needing to run; y = these tourists.

pg069

"No m' are x';
All y are m.
All y are x'."

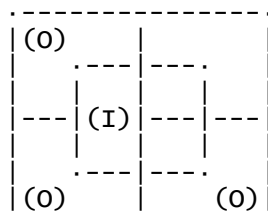

There is no Conclusion.

[Here is another opportunity, gentle Reader, for playing a trick on your innocent friend. Put the proposed Syllogism before him, and ask him what he thinks of the Conclusion.

He will reply "why, it's perfectly correct, of course! And if your precious Logic-book tells you it isn't, don't believe it! You don't mean to tell me those tourists need to run? If I were one of them, and knew the Premises to be true, I should be quite clear that I needn't run--and I should walk!"

And you will reply "But suppose there was a mad bull behind you?"

And then your innocent friend will say "Hum! Ha! I must think that over a bit!"

You may then explain to him, as a convenient test of the soundness of a Syllogism, that, if circumstances can be invented which, without interfering with the truth of the Premises, would make the Conclusion false, the Syllogism must be unsound.]

[Review Tables V-VIII (pp. 46-49). work Examples § =4=, 7-12 (p. 100); § =5=, 7-12 (p. 101); § =6=, 1-10 (p. 106); § =7=, 1-6 (pp. 107, 108).]

pg070

BOOK VI.

THE METHOD OF SUBSCRIPTS.

CHAPTER I.

INTRODUCTORY.

Let us agree that "x₁" shall mean "Some existing Things have the Attribute x", i.e. (more briefly) "Some x exist"; also that "xy₁" shall mean "Some xy exist", and so on. Such a Proposition may be called an '=Entity=.'

Symbolic Logic

[Note that, when there are two letters in the expression, it does not in the least matter which stands first: "xy_{1}" and "yx_{1}" mean exactly the same.]

Also that "x_{0}" shall mean "No existing Things have the Attribute x", i.e. (more briefly) "No x exist"; also that "xy_{0}" shall mean "No xy exist", and so on. Such a Proposition may be called a '=Nullity='.

Also that "+" shall mean "and".

[Thus "ab_{1} + cd_{0}" means "Some ab exist and no cd exist".]

Also that "¶" shall mean "would, if true, prove".

[Thus, "x_{0} ¶ xy_{0}" means "The Proposition 'No x exist' would, if true, prove the Proposition 'No xy exist'".]

When two Letters are both of them accented, or both not accented, they are said to have '=Like Signs=', or to be '=Like=': when one is accented, and the other not, they are said to have '=Unlike Signs=', or to be '=Unlike='.

pg071

CHAPTER II.

REPRESENTATION OF PROPOSITIONS OF RELATION.

Let us take, first, the Proposition "Some x are y".

This, we know, is equivalent to the Proposition of Existence "Some xy exist". (See p. 31.) Hence it may be represented by the expression "xy_{1}".

The Converse Proposition "Some y are x" may of course be represented by the same expression, viz. "xy_{1}".

Similarly we may represent the three similar Pairs of Converse Propositions, viz.--

"Some x are y'" = "Some y' are x",
 "Some x' are y" = "Some y are x'",
 "Some x' are y'" = "Some y' are x'".

Let us take, next, the Proposition "No x are y".

This, we know, is equivalent to the Proposition of Existence "No xy exist". (See p. 33.) Hence it may be represented by the expression "xy_{0}".

The Converse Proposition "No y are x" may of course be represented by the same expression, viz. "xy_{0}".

Similarly we may represent the three similar Pairs of Converse Propositions, viz.--

"No x are y'" = "No y' are x",
 "No x' are y" = "No y are x'",
 "No x' are y'" = "No y' are x'".

pg072

Let us take, next, the Proposition "All x are y".

Now it is evident that the Double Proposition of Existence "Some x exist and no xy' exist" tells us that some x-Things exist, but that none of them have the Attribute y': that is, it tells us that all of them have the Attribute y: that is, it tells us that "All x are y".

Symbolic Logic

Also it is evident that the expression " $x_{\{1\}} + xy'_{\{0\}}$ " represents this Double Proposition.

Hence it also represents the Proposition "All x are y".

[The Reader will perhaps be puzzled by the statement that the Proposition "All x are y" is equivalent to the Double Proposition "Some x exist and no xy' exist," remembering that it was stated, at p. 33, to be equivalent to the Double Proposition "Some x are y and no x are y'" (i.e. "Some xy exist and no xy' exist"). The explanation is that the Proposition "Some xy exist" contains superfluous information. "Some x exist" is enough for our purpose.]

This expression may be written in a shorter form, viz. " $x_{\{1\}}y'_{\{0\}}$ ", since each Subscript takes effect back to the beginning of the expression.

Similarly we may represent the seven similar Propositions "All x are y'", "All x' are y", "All x' are y'", "All y are x", "All y are x'", "All y' are x", and "All y' are x'".

[The Reader should make out all these for himself.]

It will be convenient to remember that, in translating a Proposition, beginning with "All", from abstract form into subscript form, or vice versa, the Predicate changes sign (that is, changes from positive to negative, or else from negative to positive).

[Thus, the Proposition "All y are x'" becomes " $y_{\{1\}}x_{\{0\}}$ ", where the Predicate changes from x' to x.

Again, the expression " $x'_{\{1\}}y'_{\{0\}}$ " becomes "All x' are y", where the Predicate changes for y' to y.]

pg073

CHAPTER III.

SYLLOGISMS.

§ 1.

Representation of Syllogisms.

We already know how to represent each of the three Propositions of a Syllogism in subscript form. When that is done, all we need, besides, is to write the three expressions in a row, with "+" between the Premises, and "¶" before the Conclusion.

[Thus the Syllogism

"No x are m';
All m are y.
.'. No x are y'."

may be represented thus:--

$xm'_{\{0\}} + m_{\{1\}}y'_{\{0\}} \parallel xy'_{\{0\}}$

When a Proposition has to be translated from concrete form into subscript form, the Reader will find it convenient, just at first, to translate it into abstract form, and thence into subscript form. But, after a little practice, he will find it quite easy to go straight from concrete form to subscript form.]

§ 2.

Formulae for solving Problems in Syllogisms.

When once we have found, by Diagrams, the Conclusion to a given Pair of Premises, and have represented the Syllogism in subscript form, we have a Formula, by which we can at once find, without having to use Diagrams again, the Conclusion to any other Pair of Premises having the same subscript forms.

[Thus, the expression

$$xm_{\{0\}} + ym'_{\{0\}} \uparrow xy_{\{0\}}$$

is a Formula, by which we can find the Conclusion to any Pair of Premises whose subscript forms are

$$xm_{\{0\}} + ym'_{\{0\}}$$

For example, suppose we had the Pair of Propositions

"No gluttons are healthy;
No unhealthy men are strong".

proposed as Premises. Taking "men" as our 'Universe', and making m = healthy; x = gluttons; y = strong; we might translate the Pair into abstract form, thus:--

"No x are m;
No m' are y".

These, in subscript form, would be

$$xm_{\{0\}} + m'y_{\{0\}}$$

which are identical with those in our Formula. Hence we at once know the Conclusion to be

$$xy_{\{0\}}$$

that is, in abstract form,

"No x are y";

that is, in concrete form,

"No gluttons are strong".]

I shall now take three different forms of Pairs of Premises, and work out their Conclusions, once for all, by Diagrams; and thus obtain some useful Formulae. I shall call them "Fig. I", "Fig. II", and "Fig. III".

Fig. I.

This includes any Pair of Premises which are both of them Nullities, and which contain Unlike Eliminands.

The simplest case is

$$xm_{\{0\}} + ym'_{\{0\}}$$

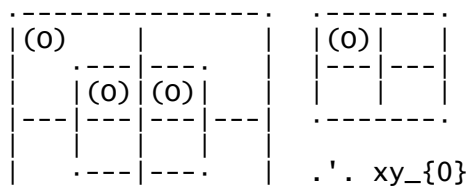

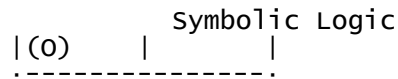

In this case we see that the Conclusion is a Nullity, and that the Retinends have kept their Signs.

And we should find this Rule to hold good with any Pair of Premisses which fulfil the given conditions.

[The Reader had better satisfy himself of this, by working out, on Diagrams, several varieties, such as

$$\begin{aligned}
 & m_{\{1\}}x_{\{0\}} + ym'_{\{0\}} \text{ (which } \nabla xy_{\{0\}}) \\
 & xm'_{\{0\}} + m_{\{1\}}y_{\{0\}} \text{ (which } \nabla xy_{\{0\}}) \\
 & x'm_{\{0\}} + ym'_{\{0\}} \text{ (which } \nabla x'y_{\{0\}}) \\
 & m'_{\{1\}}x'_{\{0\}} + m_{\{1\}}y'_{\{0\}} \text{ (which } \nabla x'y'_{\{0\}}).]
 \end{aligned}$$

If either Retinend is asserted in the Premisses to exist, of course it may be so asserted in the Conclusion.

Hence we get two Variants of Fig. I, viz.

- (a) where one Retinend is so asserted;
- (b) where both are so asserted.

[The Reader had better work out, on Diagrams, examples of these two Variants, such as

$$\begin{aligned}
 & m_{\{1\}}x_{\{0\}} + y_{\{1\}}m'_{\{0\}} \text{ (which proves } y_{\{1\}}x_{\{0\}}) \\
 & x_{\{1\}}m'_{\{0\}} + m_{\{1\}}y_{\{0\}} \text{ (which proves } x_{\{1\}}y_{\{0\}}) \\
 & x'_{\{1\}}m_{\{0\}} + y_{\{1\}}m'_{\{0\}} \text{ (which proves } x'_{\{1\}}y_{\{0\}} + y_{\{1\}}x'_{\{0\}}).]
 \end{aligned}$$

The Formula, to be remembered, is

$$xm_{\{0\}} + ym'_{\{0\}} \nabla xy_{\{0\}}$$

with the following two Rules:--

- (1) Two Nullities, with Unlike Eliminands, yield a Nullity, in which both Retinends keep their Signs.
- (2) A Retinend, asserted in the Premisses to exist, may be so asserted in the Conclusion.

pg076

[Note that Rule (1) is merely the Formula expressed in words.]

Fig. II.

This includes any Pair of Premisses, of which one is a Nullity and the other an Entity, and which contain Like Eliminands.

The simplest case is

$$xm_{\{0\}} + ym_{\{1\}}$$

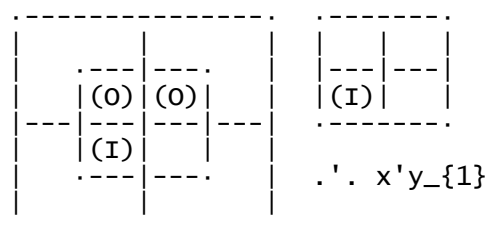

In this case we see that the Conclusion is an Entity, and that the

Symbolic Logic

Nullity-Retinend has changed its Sign.

And we should find this Rule to hold good with any Pair of Premisses which fulfil the given conditions.

[The Reader had better satisfy himself of this, by working out, on Diagrams, several varieties, such as

$$\begin{aligned} &x'm_{\{0\}} + ym_{\{1\}} \text{ (which } \neg xy_{\{1\}}) \\ &x_{\{1\}}m'_{\{0\}} + y'm'_{\{1\}} \text{ (which } \neg x'y'_{\{1\}}) \\ &m_{\{1\}}x_{\{0\}} + y'm_{\{1\}} \text{ (which } \neg x'y'_{\{1\}}). \end{aligned}$$

The Formula, to be remembered, is,

$$xm_{\{0\}} + ym_{\{1\}} \neg x'y_{\{1\}}$$

with the following Rule:--

A Nullity and an Entity, with Like Eliminands, yield an Entity, in which the Nullity-Retinend changes its Sign.

[Note that this Rule is merely the Formula expressed in words.]

pg077

Fig. III.

This includes any Pair of Premisses which are both of them Nullities, and which contain Like Eliminands asserted to exist.

The simplest case is

$$xm_{\{0\}} + ym_{\{0\}} + m_{\{1\}}$$

[Note that "m_{\{1\}}" is here stated separately, because it does not matter in which of the two Premisses it occurs: so that this includes the three forms "m_{\{1\}}x_{\{0\}} + ym_{\{0\}}", "xm_{\{0\}} + m_{\{1\}}y_{\{0\}}", and "m_{\{1\}}x_{\{0\}} + m_{\{1\}}y_{\{0\}}".]

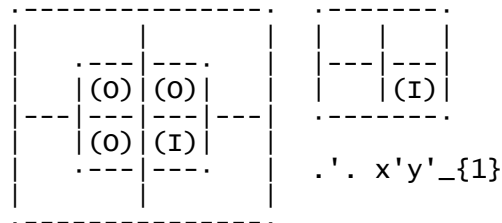

In this case we see that the Conclusion is an Entity, and that both Retinends have changed their Signs.

And we should find this Rule to hold good with any Pair of Premisses which fulfil the given conditions.

[The Reader had better satisfy himself of this, by working out, on Diagrams, several varieties, such as

$$\begin{aligned} &x'm_{\{0\}} + m_{\{1\}}y_{\{0\}} \text{ (which } \neg xy'_{\{1\}}) \\ &m'_{\{1\}}x_{\{0\}} + m'y'_{\{0\}} \text{ (which } \neg x'y_{\{1\}}) \\ &m_{\{1\}}x'_{\{0\}} + m_{\{1\}}y'_{\{0\}} \text{ (which } \neg xy_{\{1\}}). \end{aligned}$$

The Formula, to be remembered, is

$$xm_{\{0\}} + ym_{\{0\}} + m_{\{1\}} \neg x'y'_{\{1\}}$$

with the following Rule (which is merely the Formula expressed in words):--

Symbolic Logic

Two Nullities, with Like Eliminands asserted to exist, yield an Entity, in which both Retinends change their Signs.

* * * * *

In order to help the Reader to remember the peculiarities and Formulæ of these three Figures, I will put them all together in one Table.

pg078

TABLE IX.

<p>Fig. I.</p> $xm_{\{0\}} + ym'_{\{0\}} \uparrow xy_{\{0\}}$ <p>Two Nullities, with Unlike Eliminands, yield a Nullity, in which both Retinends keep their Signs.</p> <p>A Retinend, asserted in the Premisses to exist, may be so asserted in the Conclusion.</p>
<p>Fig. II.</p> $xm_{\{0\}} + ym_{\{1\}} \uparrow x'y_{\{1\}}$ <p>A Nullity and an Entity, with Like Eliminands, yield an Entity, in which the Nullity-Retinend changes its Sign.</p>
<p>Fig. III.</p> $xm_{\{0\}} + ym_{\{0\}} + m_{\{1\}} \uparrow x'y'_{\{1\}}$ <p>Two Nullities, with Like Eliminands asserted to exist, yield an Entity, in which both Retinends change their Signs.</p>

I will now work out, by these Formulæ, as models for the Reader to imitate, some Problems in Syllogisms which have been already worked, by Diagrams, in Book V., Chap. II.

(1) [see p. 64]

"No son of mine is dishonest;
People always treat an honest man with respect."

Univ. "men"; m = honest; x = my sons; y = treated with respect.

$xm'_{\{0\}} + m_{\{1\}}y'_{\{0\}} \uparrow xy'_{\{0\}}$ [Fig. I.]

i.e. "No son of mine ever fails to be treated with respect."

pg079

(2) [see p. 64]

"All cats understand French;
Some chickens are cats."

Univ. "creatures"; m = cats; x = understanding French; y = chickens.

$m_{\{1\}}x'_{\{0\}} + ym_{\{1\}} \uparrow xy_{\{1\}}$ [Fig. II.]

i.e. "Some chickens understand French."

(3) [see p. 64]

Symbolic Logic

"All diligent students are successful;
All ignorant students are unsuccessful."

Univ. "students"; m = successful; x = diligent; y = ignorant.

$x_{\{1\}m'_{\{0\}} + y_{\{1\}m_{\{0\}} \nRightarrow x_{\{1\}y_{\{0\}} + y_{\{1\}x_{\{0\}}$ [Fig. I (b)].

i.e. "All diligent students are learned; and all ignorant students are idle."

(4) [see p. 66]

"All soldiers are strong;
All soldiers are brave.
Some strong men are brave."

Univ. "men"; m = soldiers; x = strong; y = brave.

$m_{\{1\}x'_{\{0\}} + m_{\{1\}y'_{\{0\}} \nRightarrow xy_{\{1\}}$ [Fig. III].

Hence proposed Conclusion is right.

(5) [see p. 67]

"I admire these pictures;
When I admire anything, I wish to examine it thoroughly.
I wish to examine some of these pictures thoroughly."

Univ. "things"; m = admired by me; x = these; y = things which I wish to examine thoroughly.

$x_{\{1\}m'_{\{0\}} + m_{\{1\}y'_{\{0\}} \nRightarrow x_{\{1\}y'_{\{0\}}$ [Fig. I (a)].

Hence proposed Conclusion, $xy_{\{1\}}$, is incomplete, the complete one being "I wish to examine all these pictures thoroughly."

pg080

(6) [see p. 67]

"None but the brave deserve the fair;
Some braggarts are cowards.
Some braggarts do not deserve the fair."

Univ. "persons"; m = brave; x = deserving of the fair; y = braggarts.

$m'x_{\{0\}} + ym'_{\{1\}} \nRightarrow x'y_{\{1\}}$ [Fig. II].

Hence proposed Conclusion is right.

(7) [see p. 69]

"No one, who means to go by the train and cannot get a conveyance, and has not enough time to walk to the station, can do without running;

This party of tourists mean to go by the train and cannot get a conveyance, but they have plenty of time to walk to the station.

This party of tourists need not run."

Univ. "persons meaning to go by the train, and unable to get a conveyance"; m = having enough time to walk to the station; x = needing to run; y = these tourists.

$m'x'_{\{0\}} + y_{\{1\}m'_{\{0\}}$ do not come under any of the three Figures. Hence it is necessary to return to the Method of Diagrams, as shown at p. 69.

Hence there is no conclusion.

Symbolic Logic

[work Examples § =4=, 12-20 (p. 100); § =5=, 13-24 (pp. 101, 102); § =6=, 1-6 (p. 106); § =7=, 1-3 (pp. 107, 108). Also read Note (A), at p. 164.]

pg081

§ 3.

Fallacies.

Any argument which deceives us, by seeming to prove what it does not really prove, may be called a 'Fallacy' (derived from the Latin verb fallo "I deceive"): but the particular kind, to be now discussed, consists of a Pair of Propositions, which are proposed as the Premisses of a Syllogism, but yield no Conclusion.

When each of the proposed Premisses is a Proposition in I, or E, or A, (the only kinds with which we are now concerned,) the Fallacy may be detected by the 'Method of Diagrams,' by simply setting them out on a Trilateral Diagram, and observing that they yield no information which can be transferred to the Biliteral Diagram.

But suppose we were working by the 'Method of Subscripts,' and had to deal with a Pair of proposed Premisses, which happened to be a 'Fallacy,' how could we be certain that they would not yield any conclusion?

Our best plan is, I think, to deal with Fallacies in the same was as we have already dealt with Syllogisms: that is, to take certain forms of Pairs of Propositions, and to work them out, once for all, on the Trilateral Diagram, and ascertain that they yield no Conclusion; and then to record them, for future use, as Formulæ for Fallacies, just as we have already recorded our three Formulæ for Syllogisms.

pg082

Now, if we were to record the two Sets of Formulæ in the same shape, viz. by the Method of Subscripts, there would be considerable risk of confusing the two kinds. Hence, in order to keep them distinct, I propose to record the Formulæ for Fallacies in words, and to call them "Forms" instead of "Formulæ."

Let us now proceed to find, by the Method of Diagrams, three "Forms of Fallacies," which we will then put on record for future use. They are as follows:--

- (1) Fallacy of Like Eliminands not asserted to exist.
- (2) Fallacy of Unlike Eliminands with an Entity-Premiss.
- (3) Fallacy of two Entity-Premisses.

These shall be discussed separately, and it will be seen that each fails to yield a Conclusion.

(1) Fallacy of Like Eliminands not asserted to exist.

It is evident that neither of the given Propositions can be an Entity, since that kind asserts the existence of both of its Terms (see p. 20). Hence they must both be Nullities.

Hence the given Pair may be represented by $(x_m\{0} + y_m\{0})$, with or without $x_{\{1}$, $y_{\{1}$.

These, set out on Trilateral Diagrams, are

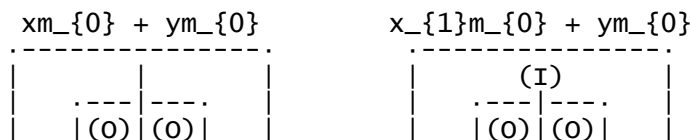

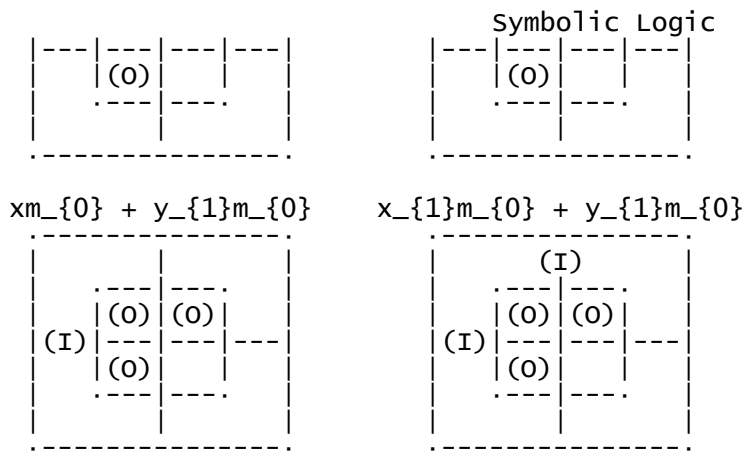

pg083

(2) Fallacy of Unlike Eliminands with an Entity-Premiss.

Here the given Pair may be represented by $(xm_{0} + ym'_{1})$ with or without x_{1} or m_{1} .

These, set out on Trilateral Diagrams, are

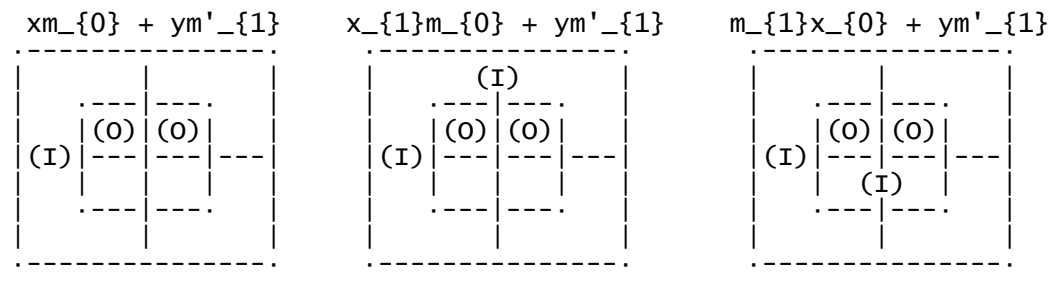

(3) Fallacy of two Entity-Premisses.

Here the given Pair may be represented by either $(xm_{1} + ym_{1})$ or $(xm_{1} + ym'_{1})$.

These, set out on Trilateral Diagrams, are

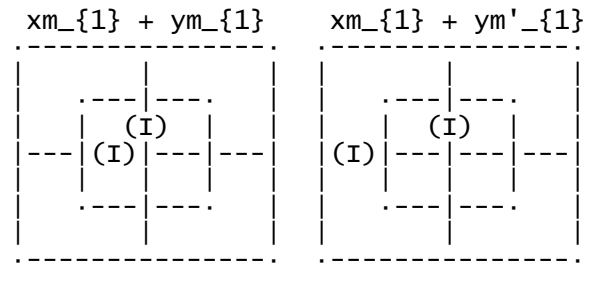

pg084

§ 4.

Method of proceeding with a given Pair of Propositions.

Let us suppose that we have before us a Pair of Propositions of Relation, which contain between them a Pair of codivisional Classes, and that we wish to ascertain what Conclusion, if any, is consequent from them. We translate them, if necessary, into subscript-form, and then proceed as follows:--

- (1) We examine their Subscripts, in order to see whether they are
 - (a) a Pair of Nullities;
 - or (b) a Nullity and an Entity;

Symbolic Logic

or (c) a Pair of Entities.

(2) If they are a Pair of Nullities, we examine their Eliminands, in order to see whether they are Unlike or Like.

If their Eliminands are Unlike, it is a case of Fig. I. We then examine their Retinends, to see whether one or both of them are asserted to exist. If one Retinend is so asserted, it is a case of Fig. I (a); if both, it is a case of Fig. I (b).

If their Eliminands are Like, we examine them, in order to see whether either of them is asserted to exist. If so, it is a case of Fig. III.; if not, it is a case of "Fallacy of Like Eliminands not asserted to exist."

(3) If they are a Nullity and an Entity, we examine their Eliminands, in order to see whether they are Like or Unlike.

If their Eliminands are Like, it is a case of Fig. II.; if Unlike, it is a case of "Fallacy of Unlike Eliminands with an Entity-Premiss."

(4) If they are a Pair of Entities, it is a case of "Fallacy of two Entity-Premises."

[work Examples § =4=, 1-11 (p. 100); § =5=, 1-12 (p. 101); § =6=, 7-12 (p. 106); § =7=, 7-12 (p. 108).]

pg085

BOOK VII.

SORITESSES.

CHAPTER I.

INTRODUCTORY.

When a Set of three or more Biliteral Propositions are such that all their Terms are Species of the same Genus, and are also so related that two of them, taken together, yield a Conclusion, which, taken with another of them, yields another Conclusion, and so on, until all have been taken, it is evident that, if the original Set were true, the last Conclusion would also be true.

Such a Set, with the last Conclusion tacked on, is called a '=Sorites='; the original Set of Propositions is called its '=Premises='; each of the intermediate Conclusions is called a '=Partial Conclusion=' of the Sorites; the last Conclusion is called its '=Complete Conclusion=', or, more briefly, its '=Conclusion='; the Genus, of which all the Terms are Species, is called its '=Universe of Discourse=', or, more briefly, its '=Univ.='; the Terms, used as Eliminands in the Syllogisms, are called its '=Eliminands='; and the two Terms, which are retained, and therefore appear in the Conclusion, are called its '=Retinends='.

[Note that each Partial Conclusion contains one or two Eliminands; but that the Complete Conclusion contains Retinends only.]

The Conclusion is said to be '=consequent=' from the Premises; for which reason it is usual to prefix to it the word "Therefore" (or the symbol ".'.").

[Note that the question, whether the Conclusion is or is not

Symbolic Logic

consequent from the Premises, is not affected by the actual truth or falsity of any one of the Propositions which make up the Sorites, by depends entirely on their relationship to one another.

pg086

As a specimen-Sorites, let us take the following Set of 5 Propositions:--

- (1) "No a are b'";
- (2) All b are c;
- (3) All c are d;
- (4) No e' are a'";
- (5) All h are e'".

Here the first and second, taken together, yield "No a are c'".

This, taken along with the third, yields "No a are d'".

This, taken along with the fourth, yields "No d' are e'".

And this, taken along with the fifth, yields "All h are d'".

Hence, if the original Set were true, this would also be true.

Hence the original Set, with this tacked on, is a Sorites; the original Set is its Premises; the Proposition "All h are d'" is its Conclusion; the Terms a, b, c, e are its Eliminands; and the Terms d and h are its Retinends.

Hence we may write the whole Sorites thus:--

"No a are b';
 All b are c;
 All c are d;
 No e' are a';
 All h are e'.
 ∴ All h are d".

In the above Sorites, the 3 Partial Conclusions are the Positions "No a are e'", "No a are d'", "No d' are e'"; but, if the Premises were arranged in other ways, other Partial Conclusions might be obtained. Thus, the order 41523 yields the Partial Conclusions "No c' are b'", "All h are b", "All h are c". There are altogether nine Partial Conclusions to this Sorites, which the Reader will find it an interesting task to make out for himself.]

pg087

CHAPTER II.

PROBLEMS IN SORITESES.

§ 1.

Introductory.

The Problems we shall have to solve are of the following form:--

"Given three or more Propositions of Relation, which are proposed as Premises: to ascertain what Conclusion, if any, is consequent from them."

We will limit ourselves, at present, to Problems which can be worked by the Formulæ of Fig. I. (See p. 75.) Those, that require other Formulæ, are rather too hard for beginners.

Symbolic Logic

Such Problems may be solved by either of two Methods, viz.

- (1) The Method of Separate Syllogisms;
- (2) The Method of Underscoring.

These shall be discussed separately.

pg088

§ 2.

Solution by Method of Separate Syllogisms.

The Rules, for doing this, are as follows:--

- (1) Name the 'Universe of Discourse'.
- (2) Construct a Dictionary, making a, b, c, &c. represent the Terms.
- (3) Put the Proposed Premisses into subscript form.
- (4) Select two which, containing between them a pair of codivisional Classes, can be used as the Premisses of a Syllogism.
- (5) Find their Conclusion by Formula.
- (6) Find a third Premiss which, along with this Conclusion, can be used as the Premisses of a second Syllogism.
- (7) Find a second Conclusion by Formula.
- (8) Proceed thus, until all the proposed Premisses have been used.
- (9) Put the last Conclusion, which is the Complete Conclusion of the Sorites, into concrete form.

[As an example of this process, let us take, as the proposed Set of Premisses,

- (1) "All the policemen on this beat sup with our cook;
- (2) No man with long hair can fail to be a poet;
- (3) Amos Judd has never been in prison;
- (4) Our cook's 'cousins' all love cold mutton;
- (5) None but policemen on this beat are poets;
- (6) None but her 'cousins' ever sup with our cook;
- (7) Men with short hair have all been in prison."

Univ. "men"; a = Amos Judd; b = cousins of our cook; c = having been in prison; d = long-haired; e = loving cold mutton; h = poets; k = policemen on this beat; l = supping with our cook

pg089

We now have to put the proposed Premisses into subscript form. Let us begin by putting them into abstract form. The result is

- (1) "All k are l;
- (2) No d are h';
- (3) All a are c';
- (4) All b are e;
- (5) No k' are h;
- (6) No b' are l;
- (7) All d' are c."

And it is now easy to put them into subscript form, as follows:--

- (1) $k_{\{1\}}l'_{\{0\}}$

Symbolic Logic

- (2) dh'_{0}
- (3) $a_{1}c_{0}$
- (4) $b_{1}e'_{0}$
- (5) $k'h_{0}$
- (6) $b'l_{0}$
- (7) $d'_{1}c'_{0}$

We now have to find a pair of Premisses which will yield a Conclusion. Let us begin with No. (1), and look down the list, till we come to one which we can take along with it, so as to form Premisses belonging to Fig. I. We find that No. (5) will do, since we can take k as our Eliminand. So our first syllogism is

- (1) $k_{1}l'_{0}$
- (5) $k'h_{0}$
- ∴ $l'h_{0}$... (8)

We must now begin again with $l'h_{0}$ and find a Premiss to go along with it. We find that No. (2) will do, h being our Eliminand. So our next Syllogism is

- (8) $l'h_{0}$
- (2) dh'_{0}
- ∴ $l'd_{0}$... (9)

We have now used up Nos. (1), (5), and (2), and must search among the others for a partner for $l'd_{0}$. We find that No. (6) will do. So we write

- (9) $l'd_{0}$
- (6) $b'l_{0}$
- ∴ db'_{0} ... (10)

Now what can we take along with db'_{0} ? No. (4) will do.

- (10) db'_{0}
- (4) $b_{1}e'_{0}$
- ∴ de'_{0} ... (11)

pg090

Along with this we may take No. (7).

- (11) de'_{0}
- (7) $d'_{1}c'_{0}$
- ∴ $c'e'_{0}$... (12)

And along with this we may take No. (3).

- (12) $c'e'_{0}$
- (3) $a_{1}c_{0}$
- ∴ $a_{1}e'_{0}$

This complete Conclusion, translated into abstract form, is

"All a are e ";

and this, translated into concrete form, is

"Amos Judd loves cold mutton."

In actually working this Problem, the above explanations would, of course, be omitted, and all, that would appear on paper, would be as follows:--

- (1) $k_{1}l'_{0}$
- (2) dh'_{0}
- (3) $a_{1}c_{0}$
- (4) $b_{1}e'_{0}$

Symbolic Logic

- (5) $k'h_{\{0\}}$
 (6) $b'l_{\{0\}}$
 (7) $d'_{\{1\}}c'_{\{0\}}$
- (1) $k_{\{1\}}l'_{\{0\}}$
 (5) $k'h_{\{0\}}$
 ∴ $l'h_{\{0\}}$... (8)
- (8) $l'h_{\{0\}}$
 (2) $dh'_{\{0\}}$
 ∴ $l'd_{\{0\}}$... (9)
- (9) $l'd_{\{0\}}$
 (6) $b'l_{\{0\}}$
 ∴ $db'_{\{0\}}$... (10)
- (10) $db'_{\{0\}}$
 (4) $b_{\{1\}}e'_{\{0\}}$
 ∴ $de'_{\{0\}}$... (11)
- (11) $de'_{\{0\}}$
 (7) $d'_{\{1\}}c'_{\{0\}}$
 ∴ $c'e'_{\{0\}}$... (12)
- (12) $c'e'_{\{0\}}$
 (3) $a_{\{1\}}c_{\{0\}}$
 ∴ $a_{\{1\}}e'_{\{0\}}$

Note that, in working a Sorites by this Process, we may begin with any Premiss we choose.]

pg091

§ 3.

Solution by Method of Underscoring.

Consider the Pair of Premisses

$$xm_{\{0\}} + ym'_{\{0\}}$$

which yield the Conclusion $xy_{\{0\}}$

We see that, in order to get this Conclusion, we must eliminate m and m' , and write x and y together in one expression.

Now, if we agree to mark m and m' as eliminated, and to read the two expressions together, as if they were written in one, the two Premisses will then exactly represent the Conclusion, and we need not write it out separately.

Let us agree to mark the eliminated letters by underscoring them, putting a single score under the first, and a double one under the second.

The two Premisses now become

$$\underline{x}m_{\{0\}} + y\underline{m}'_{\{0\}}$$

which we read as " $xy_{\{0\}}$ ".

In copying out the Premisses for underscoring, it will be convenient to omit all subscripts. As to the "0's" we may always suppose them written, and, as to the "1's", we are not concerned to know which Terms are asserted to exist, except those which appear in the Complete Conclusion; and for them it will be easy enough to refer to the original list.

[I will now go through the process of solving, by this method, the example worked in § 2.

The Data are

$$\begin{array}{cccc} 1 & 2 & 3 & 4 \\ k_{\{1\}}l'_{\{0\}} + dh'_{\{0\}} + a_{\{1\}}c_{\{0\}} + b_{\{1\}}e'_{\{0\}} + \\ 5 & 6 & 7 \\ k'h_{\{0\}} + b'l_{\{0\}} + d'_{\{1\}}c'_{\{0\}} \end{array}$$

The Reader should take a piece of paper, and write out this solution for himself. The first line will consist of the above Data; the second must be composed, bit by bit, according to the following directions.

We begin by writing down the first Premiss, with its numeral over it, but omitting the subscripts.

We have now to find a Premiss which can be combined with this, i.e., a Premiss containing either k' or l . The first we find is No. 5; and this we tack on, with a +.

To get the Conclusion from these, k and k' must be eliminated, and what remains must be taken as one expression. So we underscore them, putting a single score under k , and a double one under k' . The result we read as $l'h$.

We must now find a Premiss containing either l or h' . Looking along the row, we fix on No. 2, and tack it on.

Now these 3 Nullities are really equivalent to $(l'h + dh')$, in which h and h' must be eliminated, and what remains taken as one expression. So we underscore them. The result reads as $l'd$.

We now want a Premiss containing l or d' . No. 6 will do.

These 4 Nullities are really equivalent to $(l'd + b'l)$. So we underscore l' and l . The result reads as db' .

We now want a Premiss containing d' or b . No. 4 will do.

Here we underscore b' and b . The result reads as de' .

We now want a Premiss containing d' or e . No. 7 will do.

Here we underscore d and d' . The result reads as $c'e'$.

We now want a Premiss containing c or e . No. 3 will do--in fact must do, as it is the only one left.

Here we underscore c' and c ; and, as the whole thing now reads as $e'a$, we tack on $e'a_{\{0\}}$ as the Conclusion, with a ¶.

We now look along the row of Data, to see whether e' or a has been given as existent. We find that a has been so given in No. 3. So we add this fact to the Conclusion, which now stands as ¶ $e'a_{\{0\}} + a_{\{1\}}$, i.e. ¶ $a_{\{1\}}e'_{\{0\}}$; i.e. "All a are e ."

If the Reader has faithfully obeyed the above directions, his written solution will now stand as follows:--

$$\begin{array}{cccc} 1 & 2 & 3 & 4 \\ k_{\{1\}}l'_{\{0\}} + dh'_{\{0\}} + a_{\{1\}}c_{\{0\}} + b_{\{1\}}e'_{\{0\}} + \\ 5 & 6 & 7 \\ k'h_{\{0\}} + b'l_{\{0\}} + d'_{\{1\}}c'_{\{0\}} \end{array}$$

Symbolic Logic

$$\begin{array}{ccccccc} 1 & 5 & 2 & 6 & 4 & 7 & 3 \\ kl' & + & k'h & + & dh' & + & b'l & + & be' & + & d'c' & + & ac \\ -- & = & - & -- & = & = & - & = & - & = & - & = & - \end{array}$$

$$\neg e'a_{\{0\}} + a_{\{1\}}$$

$$\text{i.e. } \neg a_{\{1\}}e'_{\{0\}};$$

i.e. "All a are e."

pg093

The Reader should now take a second piece of paper, and copy the Data only, and try to work out the solution for himself, beginning with some other Premiss.

If he fails to bring out the Conclusion $a_{\{1\}}e'_{\{0\}}$, I would advise him to take a third piece of paper, and begin again!

I will now work out, in its briefest form, a Sorites of 5 Premisses, to serve as a model for the Reader to imitate in working examples.

- (1) "I greatly value everything that John gives me;
- (2) Nothing but this bone will satisfy my dog;
- (3) I take particular care of everything that I greatly value;
- (4) This bone was a present from John;
- (5) The things, of which I take particular care, are things I do not give to my dog".

Univ. "things"; a = given by John to me; b = given by me to my dog; c = greatly valued by me; d = satisfactory to my dog; e = taken particular care of by me; h = this bone.

$$\begin{array}{ccccccc} 1 & 2 & 3 & 4 & 5 \\ a_{\{1\}}c'_{\{0\}} & + & h'd_{\{0\}} & + & c_{\{1\}}e'_{\{0\}} & + & h_{\{1\}}a'_{\{0\}} & + & e_{\{1\}}b_{\{0\}} \end{array}$$

$$\begin{array}{ccccccc} 1 & 3 & 4 & 2 & 5 \\ ac' & + & ce' & + & ha' & + & h'd & + & eb & \neg & db_{\{0\}} \\ -- & = & - & = & = & = & = & = & = & = & = \end{array}$$

i.e. "Nothing, that I give my dog, satisfies him," or, "My dog is not satisfied with anything that I give him!"

[Note that, in working a Sorites by this process, we may begin with any Premiss we choose. For instance, we might begin with No. 5, and the result would then be

$$\begin{array}{ccccccc} 5 & 3 & 1 & 4 & 2 \\ eb & + & ce' & + & ac' & + & ha' & + & h'd & \neg & bd_{\{0\}} \\ - & = & - & = & - & = & - & = & = & = & = \end{array}$$

[Work Examples § =4=, 25-30 (p. 100); § =5=, 25-30 (p. 102); § =6=, 13-15 (p. 106); § =7=, 13-15 (p. 108); § =8=, 1-4, 13, 14, 19, 24 (pp. 110, 111); § =9=, 1-4, 26, 27, 40, 48 (pp. 112, 116, 119, 121).]

pg094

The Reader, who has successfully grappled with all the Examples hitherto set, and who thirsts, like Alexander the Great, for "more worlds to conquer," may employ his spare energies on the following 17 Examination-Papers. He is recommended not to attempt more than one Paper on any one day. The answers to the questions about words and phrases may be found by referring to the Index at p. 197.

- I. § =4=, 31 (p. 100); § =5=, 31-34 (p. 102); § =6=, 16, 17 (p. 106); § =7=, 16 (p. 108); § =8=, 5, 6 (p. 110); § =9=, 5, 22,

Symbolic Logic

- 42 (pp. 112, 115, 119). what is 'Classification'? And what is a 'Class'?
- II. § =4=, 32 (p. 100); § =5=, 35-38 (pp. 102, 103); § =6=, 18 (p. 107); § =7=, 17, 18 (p. 108); § =8=, 7, 8 (p. 110); § =9=, 6, 23, 43 (pp. 112, 115, 119). what are 'Genus', 'Species', and 'Differentia'?
- III. § =4=, 33 (p. 100); § =5=, 39-42 (p. 103); § =6=, 19, 20 (p. 107); § =7=, 19 (p. 109); § =8=, 9, 10 (p. 111); § =9=, 7, 24, 44 (pp. 113, 116, 120). what are 'Real' and 'Imaginary' Classes?
- IV. § =4=, 34 (p. 100); § =5=, 43-46 (p. 103); § =6=, 21 (p. 107); § =7=, 20, 21 (p. 109); § =8=, 11, 12 (p. 111); § =9=, 8, 25, 45 (pp. 113, 116, 120). what is 'Division'? When are Classes said to be 'Codivisional'?
- V. § =4=, 35 (p. 100); § =5=, 47-50 (p. 103); § =6=, 22, 23 (p. 107); § =7=, 22 (p. 109); § =8=, 15, 16 (p. 111); § =9=, 9, 28, 46 (pp. 113, 116, 120). what is 'Dichotomy'? what arbitrary rule does it sometimes require? pg095
- VI. § =4=, 36 (p. 100); § =5=, 51-54 (p. 103); § =6=, 24 (p. 107); § =7=, 23, 24 (p. 109); § =8=, 17 (p. 111); § =9=, 10, 29, 47 (pp. 113, 117, 120). what is a 'Definition'?
- VII. § =4=, 37 (p. 100); § =5=, 55-58 (pp. 103, 104); § =6=, 25, 26 (p. 107); § =7=, 25 (p. 109); § =8=, 18 (p. 111); § =9=, 11, 30, 49 (pp. 113, 117, 121). what are the 'subject' and the 'Predicate' of a Proposition? what is its 'Normal' form?
- VIII. § =4=, 38 (p. 100); § =5=, 59-62 (p. 104); § =6=, 27 (p. 107); § =7=, 26, 27 (p. 109); § =8=, 20 (p. 111); § =9=, 12, 31, 50 (pp. 113, 117, 121). what is a Proposition 'in I'? 'In E'? And 'in A'?
- IX. § =4=, 39 (p. 100); § =5=, 63-66 (p. 104); § =6=, 28, 29 (p. 107); § =7=, 28 (p. 109); § =8=, 21 (p. 111); § =9=, 13, 32, 51 (pp. 114, 117, 121). what is the 'Normal' form of a Proposition of Existence?
- X. § =4=, 40 (p. 100); § =5=, 67-70 (p. 104); § =6=, 30 (p. 107); § =7=, 29, 30 (p. 109); § =8=, 22 (p. 111); § =9=, 14, 33, 52 (pp. 114, 117, 122). what is the 'Universe of Discourse'?
- XI. § =4=, 41 (p. 100); § =5=, 71-74 (p. 104); § =6=, 31, 32 (p. 107); § =7=, 31 (p. 109); § =8=, 23 (p. 111); § =9=, 15, 34, 53 (pp. 114, 118, 122). what is implied, in a Proposition of Relation, as to the Reality of its Terms?
- XII. § =4=, 42 (p. 100); § =5=, 75-78 (p. 105); § =6=, 33 (p. 107); § =7=, 32, 33 (pp. 109, 110); § =8=, 25 (p. 111); § =9=, 16, 35, 54 (pp. 114, 118, 122). Explain the phrase "sitting on the fence".
- XIII. § =5=, 79-83 (p. 105); § =6=, 34, 35 (p. 107); § =7=, 34 (p. 110); § =8=, 26 (p. 111); § =9=, 17, 36, 55 (pp. 114, 118, 122). what are 'Converse' Propositions?
- XIV. § =5=, 84-88 (p. 105); § =6=, 36 (p. 107); § =7=, 35, 36 (p. 110); § =8=, 27 (p. 111); § =9=, 18, 37, 56 (pp. 114, 118, 123). what are 'Concrete' and 'Abstract' Propositions? pg096
- XV. § =5=, 89-93 (p. 105); § =6=, 37, 38 (p. 107); § =7=, 37 (p. 110); § =8=, 28 (p. 111); § =9=, 19, 38, 57 (pp. 115, 118, 123). what is a 'Syllogism'? And what are its 'Premisses' and

Symbolic Logic

its 'Conclusion'?

- XVI. § =5=, 94-97 (p. 106); § =6=, 39 (p. 107); § =7=, 38, 39 (p. 110); § =8=, 29 (p. 111); § =9=, 20, 39, 58 (pp. 115, 119, 123). What is a 'Sorites'? And what are its 'Premisses', its 'Partial Conclusions', and its 'Complete Conclusion'?
- XVII. § =5=, 98-101 (p. 106); § =6=, 40 (p. 107); § =7=, 40 (p. 110); § =8=, 30 (p. 111); § =9=, 21, 41, 59, 60 (pp. 115, 119, 124). What are the 'Universe of Discourse', the 'Eliminands', and the 'Retinends', of a Syllogism? And of a Sorites?

pg097

BOOK VIII.

EXAMPLES, ANSWERS, AND SOLUTIONS.

[N.B. Reference tags for Examples, Answers & Solutions will be found in the right margin.]

CHAPTER I.

EXAMPLES.

§ 1.

EX1

Propositions of Relation, to be reduced to normal form.

1. I have been out for a walk.
2. I am feeling better.
3. No one has read the letter but John.
4. Neither you nor I are old.
5. No fat creatures run well.
6. None but the brave deserve the fair.
7. No one looks poetical unless he is pale.
8. Some judges lose their tempers.
9. I never neglect important business.
10. What is difficult needs attention.
11. What is unwholesome should be avoided.
12. All the laws passed last week relate to excise.
13. Logic puzzles me.
14. There are no Jews in the house.
15. Some dishes are unwholesome if not well-cooked.
16. Unexciting books make one drowsy.
17. When a man knows what he's about, he can detect a sharper.

Symbolic Logic

18. You and I know what we're about.
19. Some bald people wear wigs.
20. Those who are fully occupied never talk about their grievances.
21. No riddles interest me if they can be solved.

§ 2.

pg098
EX2

Pairs of Abstract Propositions, one in terms of x and m, and the other in terms of y and m, to be represented on the same Trilateral Diagram.

1. No x are m;
No m' are y.
2. No x' are m';
All m' are y.
3. Some x' are m;
No m are y.
4. All m are x;
All m' are y'.
5. All m' are x;
All m' are y'.
6. All x' are m';
No y' are m.
7. All x are m;
All y' are m'.
8. Some m' are x';
No m are y.
9. All m are x';
No m are y.
10. No m are x';
No y are m'.
11. No x' are m';
No m are y.
12. Some x are m;
All y' are m.
13. All x' are m;
No m are y.
14. Some x are m';
All m are y.
15. No m' are x';
All y are m.
16. All x are m';
No y are m.
17. Some m' are x;
No m' are y'.
18. All x are m';
Some m' are y'.

Symbolic Logic

19. All m are x;
Some m are y'.
20. No x' are m;
Some y are m.
21. Some x' are m';
All y' are m.
22. No m are x;
Some m are y.
23. No m' are x;
All y are m'.
24. All m are x;
No y' are m'.
25. Some m are x;
No y' are m.
26. All m' are x';
Some y are m'.
27. Some m are x';
No y' are m'.
28. No x are m';
All m are y'.
29. No x' are m;
No m are y'.
30. No x are m;
Some y' are m'.
31. Some m' are x;
All y' are m;
32. All x are m';
All y are m.

pg099
EX3

§ 3.

Marked Trilateral Diagrams, to be interpreted in terms of x and y.

1

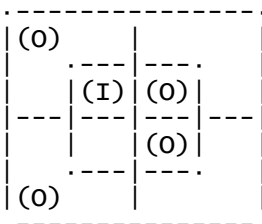

2

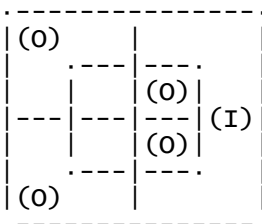

Symbolic Logic

3

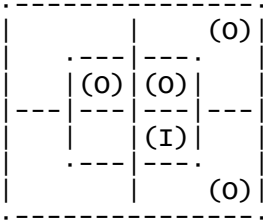

4

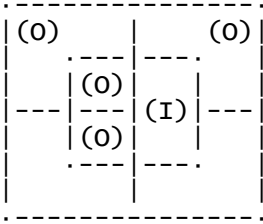

5

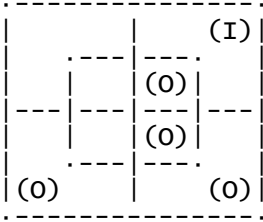

6

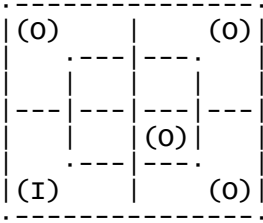

7

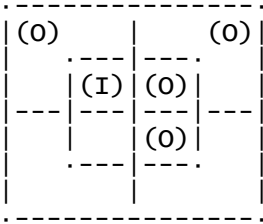

8

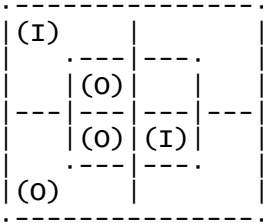

9

Symbolic Logic

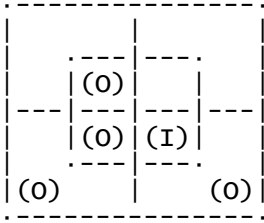

10

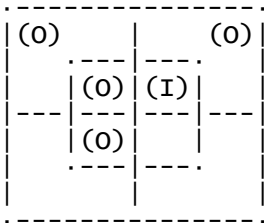

11

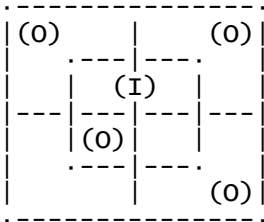

12

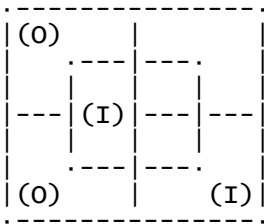

13

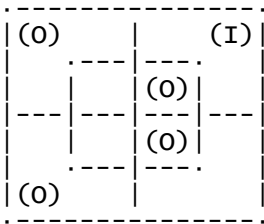

14

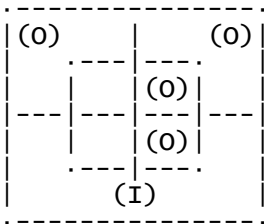

15

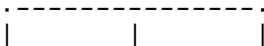

Symbolic Logic

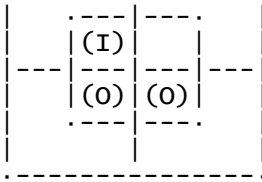

16

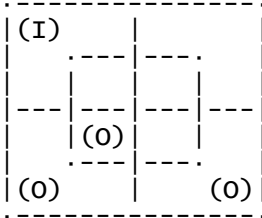

17

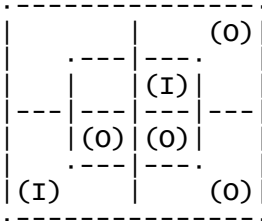

18

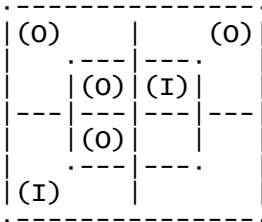

19

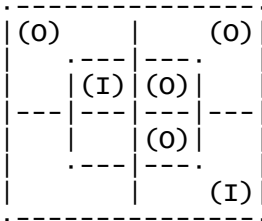

20

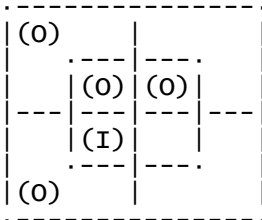

§ 4.

pg100
EX4

Pairs of Abstract Propositions, proposed as Premisses: Conclusions to be found.

Symbolic Logic

1. No m are x' ;
All m' are y .
2. No m' are x ;
Some m' are y' .
3. All m' are x ;
All m' are y' .
4. No x' are m' ;
All y' are m .
5. Some m are x' ;
No y are m .
6. No x' are m ;
No m are y .
7. No m are x' ;
Some y' are m .
8. All m' are x' ;
No m' are y .
9. Some x' are m' ;
No m are y' .
10. All x are m ;
All y' are m' .
11. No m are x ;
All y' are m' .
12. No x are m ;
All y are m .
13. All m' are x ;
No y are m .
14. All m are x ;
All m' are y .
15. No x are m ;
No m' are y .
16. All x are m' ;
All y are m .
17. No x are m ;
All m' are y .
18. No x are m' ;
No m are y .
19. All m are x ;
All m are y' .
20. No m are x ;
All m' are y .
21. All x are m ;
Some m' are y .
22. Some x are m ;
All y are m .
23. All m are x ;

Symbolic Logic

Some y are m.

24. No x are m;
All y are m.
25. Some m are x';
All y' are m'.
26. No m are x';
All y are m.
27. All x are m';
All y' are m.
28. All m are x';
Some m are y.
29. No m are x;
All y are m'.
30. All x are m';
Some y are m.
31. All x are m;
All y are m.
32. No x are m';
All m are y.
33. No m are x;
No m are y.
34. No m are x';
Some y are m.
35. No m are x;
All y are m.
36. All m are x';
Some y are m.
37. All m are x;
No y are m.
38. No m are x;
No m' are y.
39. Some m are x';
No m are y.
40. No x' are m;
All y' are m.
41. All x are m';
No y are m'.
42. No m' are x;
No y are m.

§ 5.

pg101
EX5

Pairs of Concrete Propositions, proposed as Premisses: Conclusions to be found.

1. I have been out for a walk;
I am feeling better.

Symbolic Logic

2. No one has read the letter but John;
No one, who has not read it, knows what it is about.
3. Those who are not old like walking;
You and I are young.
4. Your course is always honest;
Your course is always the best policy.
5. No fat creatures run well;
Some greyhounds run well.
6. Some, who deserve the fair, get their deserts;
None but the brave deserve the fair.
7. Some Jews are rich;
All Esquimaux are Gentiles.
8. Sugar-plums are sweet;
Some sweet things are liked by children.
9. John is in the house;
Everybody in the house is ill.
10. Umbrellas are useful on a journey;
What is useless on a journey should be left behind.
11. Audible music causes vibration in the air;
Inaudible music is not worth paying for.
12. Some holidays are rainy;
Rainy days are tiresome.
13. No Frenchmen like plumpudding;
All Englishmen like plumpudding.
14. No portrait of a lady, that makes her simper or scowl, is
satisfactory;
No photograph of a lady ever fails to make her simper or scowl.
15. All pale people are phlegmatic;
No one looks poetical unless he is pale.
16. No old misers are cheerful;
Some old misers are thin.
17. No one, who exercises self-control, fails to keep his temper;
Some judges lose their tempers.
18. All pigs are fat;
Nothing that is fed on barley-water is fat.
19. All rabbits, that are not greedy, are black;
No old rabbits are free from greediness.
20. Some pictures are not first attempts;
No first attempts are really good.
21. I never neglect important business;
Your business is unimportant.
22. Some lessons are difficult;
What is difficult needs attention.
23. All clever people are popular;
All obliging people are popular.
24. Thoughtless people do mischief;

pg102

Symbolic Logic

- No thoughtful person forgets a promise.
25. Pigs cannot fly;
Pigs are greedy.
 26. All soldiers march well;
Some babies are not soldiers.
 27. No bride-cakes are wholesome;
what is unwholesome should be avoided.
 28. John is industrious;
No industrious people are unhappy.
 29. No philosophers are conceited;
Some conceited persons are not gamblers.
 30. Some excise laws are unjust;
All the laws passed last week relate to excise.
 31. No military men write poetry;
None of my lodgers are civilians.
 32. No medicine is nice;
Senna is a medicine.
 33. Some circulars are not read with pleasure;
No begging-letters are read with pleasure.
 34. All Britons are brave;
No sailors are cowards.
 35. Nothing intelligible ever puzzles _me_;
Logic puzzles me.
 36. Some pigs are wild;
All pigs are fat.
 37. All wasps are unfriendly;
All unfriendly creatures are unwelcome.
 38. No old rabbits are greedy;
All black rabbits are greedy.
 39. Some eggs are hard-boiled;
No eggs are uncrackable.
 40. No antelope is ungraceful;
Graceful creatures delight the eye.
 41. All well-fed canaries sing loud;
No canary is melancholy if it sings loud.
 42. Some poetry is original;
No original work is producible at will.
 43. No country, that has been explored, is infested by dragons;
Unexplored countries are fascinating.
 44. No coals are white;
No niggers are white.
 45. No bridges are made of sugar;
Some bridges are picturesque.
 46. No children are patient;
No impatient person can sit still.

pg103

Symbolic Logic

47. No quadrupeds can whistle;
Some cats are quadrupeds.
48. Bores are terrible;
You are a bore.
49. Some oysters are silent;
No silent creatures are amusing.
50. There are no Jews in the house;
No Gentiles have beards a yard long.
51. Canaries, that do not sing loud, are unhappy;
No well-fed canaries fail to sing loud.
52. All my sisters have colds;
No one can sing who has a cold.
53. All that is made of gold is precious;
Some caskets are precious.
54. Some buns are rich;
All buns are nice.
55. All my cousins are unjust;
All judges are just.
56. Pain is wearisome;
No pain is eagerly wished for.
57. All medicine is nasty;
Senna is a medicine.
58. Some unkind remarks are annoying;
No critical remarks are kind.
59. No tall men have woolly hair;
Niggers have woolly hair.
60. All philosophers are logical;
An illogical man is always obstinate.
61. John is industrious;
All industrious people are happy.
62. These dishes are all well-cooked;
Some dishes are unwholesome if not well-cooked.
63. No exciting books suit feverish patients;
Unexciting books make one drowsy.
64. No pigs can fly;
All pigs are greedy.
65. When a man knows what he's about, he can detect a sharper;
You and I know what we're about.
66. Some dreams are terrible;
No lambs are terrible.
67. No bald creature needs a hairbrush;
No lizards have hair.
68. All battles are noisy;
What makes no noise may escape notice.
69. All my cousins are unjust;
No judges are unjust.

pg104

Symbolic Logic

70. All eggs can be cracked;
Some eggs are hard-boiled.
71. Prejudiced persons are untrustworthy;
Some unprejudiced persons are disliked.
72. No dictatorial person is popular;
She is dictatorial.
73. Some bald people wear wigs;
All your children have hair.
74. No lobsters are unreasonable;
No reasonable creatures expect impossibilities.
75. No nightmare is pleasant;
Unpleasant experiences are not eagerly desired.
76. No plumcakes are wholesome;
Some wholesome things are nice.
77. Nothing that is nice need be shunned;
Some kinds of jam are nice.
78. All ducks waddle;
Nothing that waddles is graceful.
79. Sandwiches are satisfying;
Nothing in this dish is unsatisfying.
80. No rich man begs in the street;
Those who are not rich should keep accounts.
81. Spiders spin webs;
Some creatures, that do not spin webs, are savage.
82. Some of these shops are not crowded;
No crowded shops are comfortable.
83. Prudent travelers carry plenty of small change;
Imprudent travelers lose their luggage.
84. Some geraniums are red;
All these flowers are red.
85. None of my cousins are just;
All judges are just.
86. No Jews are mad;
All my lodgers are Jews.
87. Busy folk are not always talking about their grievances;
Discontented folk are always talking about their grievances.
88. None of my cousins are just;
No judges are unjust.
89. All teetotalers like sugar;
No nightingale drinks wine.
90. No riddles interest me if they can be solved;
All these riddles are insoluble.
91. All clear explanations are satisfactory;
Some excuses are unsatisfactory.
92. All elderly ladies are talkative;

pg105

Symbolic Logic

All good-tempered ladies are talkative.

93. No kind deed is unlawful;
What is lawful may be done without scruple.
94. No babies are studious;
No babies are good violinists.
95. All shillings are round;
All these coins are round.
96. No honest men cheat;
No dishonest men are trustworthy.
97. None of my boys are clever;
None of my girls are greedy.
98. All jokes are meant to amuse;
No Act of Parliament is a joke.
99. No eventful tour is ever forgotten;
Uneventful tours are not worth writing a book about.
100. All my boys are disobedient;
All my girls are discontented.
101. No unexpected pleasure annoys me;
Your visit is an unexpected pleasure.

pg106

§ 6.

EX6

Trios of Abstract Propositions, proposed as syllogisms: to be examined.

- | | | |
|--------------------|----------------|-----------------|
| 1. Some x are m; | No m are y'. | Some x are y. |
| 2. All x are m; | No y are m'. | No y are x'. |
| 3. Some x are m'; | All y' are m. | Some x are y. |
| 4. All x are m; | No y are m. | All x are y'. |
| 5. Some m' are x'; | No m' are y. | Some x' are y'. |
| 6. No x' are m; | All y are m'. | All y are x'. |
| 7. Some m' are x'; | All y' are m'. | Some x' are y'. |
| 8. No m' are x'; | All y' are m'. | All y' are x. |
| 9. Some m are x'; | No m are y. | Some x' are y'. |
| 10. All m' are x'; | All m' are y. | Some y are x'. |
| 11. All x are m'; | Some y are m. | Some y are x'. |
| 12. No x are m; | No m' are y'. | No x are y'. |
| 13. No x are m; | All y' are m. | All y' are x'. |
| 14. All m' are x'; | All m' are y. | Some y are x'. |
| 15. Some m are x'; | All y are m'. | Some x' are y'. |
| 16. No x' are m; | All y' are m'. | Some y' are x. |
| 17. No m' are x; | All m' are y'. | Some x' are y'. |

Symbolic Logic

pg107

- | | | |
|--------------------|-----------------|-----------------|
| 18. No x' are m; | Some m are y. | Some x are y. |
| 19. Some m are x; | All m are y. | Some y are x'. |
| 20. No x' are m'; | Some m' are y'. | Some x are y'. |
| 21. No m are x; | All m are y'. | Some x' are y'. |
| 22. All x' are m; | Some y are m'. | All x' are y'. |
| 23. All m are x; | No m' are y'. | No x' are y'. |
| 24. All x are m'; | All m' are y. | All x are y. |
| 25. No x are m'; | All m are y. | No x are y'. |
| 26. All m are x'; | All y are m. | All y are x'. |
| 27. All x are m; | No m are y'. | All x are y. |
| 28. All x are m; | No y' are m'. | All x are y. |
| 29. No x' are m; | No m' are y'. | No x' are y'. |
| 30. All x are m; | All m are y'. | All x are y'. |
| 31. All x' are m'; | No y' are m'. | All x' are y. |
| 32. No x are m; | No y' are m'. | No x are y'. |
| 33. All m are x'; | All y' are m. | All y' are x'. |
| 34. All x are m'; | Some y are m'. | Some y are x. |
| 35. Some x are m; | All m are y. | Some x are y. |
| 36. All m are x'; | All y are m. | All y are x'. |
| 37. No m are x'; | All m are y'. | Some x are y'. |
| 38. No x are m; | No m are y'. | No x are y'. |
| 39. No m are x; | Some m are y'. | Some x' are y'. |
| 40. No m are x'; | Some y are m. | Some x are y. |

§ 7.

EX7

Trios of Concrete Propositions, proposed as Syllogisms: to be examined.

1. No doctors are enthusiastic;
You are enthusiastic.
You are not a doctor.
2. Dictionaries are useful;
Useful books are valuable.
Dictionaries are valuable.
3. No misers are unselfish;
None but misers save egg-shells.
No unselfish people save egg-shells.
4. Some epicures are ungenerous;
All my uncles are generous.
My uncles are not epicures.

5. Gold is heavy;
Nothing but gold will silence him.
Nothing light will silence him.
6. Some healthy people are fat;
No unhealthy people are strong.
Some fat people are not strong.
7. "I saw it in a newspaper."
"All newspapers tell lies."
It was a lie.
8. Some cravats are not artistic;
I admire anything artistic.
There are some cravats that I do not admire.
9. His songs never last an hour;
A song, that lasts an hour, is tedious.
His songs are never tedious.
10. Some candles give very little light;
Candles are meant to give light.
Some things, that are meant to give light, give very little.
11. All, who are anxious to learn, work hard;
Some of these boys work hard.
Some of these boys are anxious to learn.
12. All lions are fierce;
Some lions do not drink coffee.
Some creatures that drink coffee are not fierce.
13. No misers are generous;
Some old men are ungenerous.
Some old men are misers.
14. No fossil can be crossed in love;
An oyster may be crossed in love.
Oysters are not fossils.
15. All uneducated people are shallow;
Students are all educated.
No students are shallow.
16. All young lambs jump;
No young animals are healthy, unless they jump.
All young lambs are healthy.
17. Ill-managed business is unprofitable;
Railways are never ill-managed.
All railways are profitable.
18. No Professors are ignorant;
All ignorant people are vain.
No professors are vain.
19. A prudent man shuns hyænas;
No banker is imprudent.
No banker fails to shun hyænas.
20. All wasps are unfriendly;
No puppies are unfriendly.
Puppies are not wasps.
21. No Jews are honest;
Some Gentiles are rich.
Some rich people are dishonest.

Symbolic Logic

22. No idlers win fame;
Some painters are not idle.
Some painters win fame.
23. No monkeys are soldiers;
All monkeys are mischievous.
Some mischievous creatures are not soldiers.
24. All these bonbons are chocolate-creams;
All these bonbons are delicious.
Chocolate-creams are delicious.
25. No muffins are wholesome;
All buns are unwholesome.
Buns are not muffins.
26. Some unauthorised reports are false;
All authorised reports are trustworthy.
Some false reports are not trustworthy.
27. Some pillows are soft;
No pokers are soft.
Some pokers are not pillows.
28. Improbable stories are not easily believed;
None of his stories are probable.
None of his stories are easily believed.
29. No thieves are honest;
Some dishonest people are found out.
Some thieves are found out.
30. No muffins are wholesome;
All puffy food is unwholesome.
All muffins are puffy.
31. No birds, except peacocks, are proud of their tails;
Some birds, that are proud of their tails, cannot sing.
Some peacocks cannot sing.
32. Warmth relieves pain;
Nothing, that does not relieve pain, is useful in toothache.
Warmth is useful in toothache.
33. No bankrupts are rich;
Some merchants are not bankrupts.
Some merchants are rich.
34. Bores are dreaded;
No bore is ever begged to prolong his visit.
No one, who is dreaded, is ever begged to prolong his visit.
35. All wise men walk on their feet;
All unwise men walk on their hands.
No man walks on both.
36. No wheelbarrows are comfortable;
No uncomfortable vehicles are popular.
No wheelbarrows are popular.
37. No frogs are poetical;
Some ducks are unpoetical.
Some ducks are not frogs.
38. No emperors are dentists;
All dentists are dreaded by children.
No emperors are dreaded by children.

pg110

Symbolic Logic

39. Sugar is sweet;
Salt is not sweet.
Salt is not sugar.
40. Every eagle can fly;
Some pigs cannot fly.
Some pigs are not eagles.

§ 8.

EX8

Sets of Abstract Propositions, proposed as Premisses for Soriteses:
Conclusions to be found.

[N.B. At the end of this section instructions are given for
varying these Examples.]

1.

1. No c are d;
2. All a are d;
3. All b are c.

2.

1. All d are b;
2. No a are c';
3. No b are c.

3.

1. No b are a;
2. No c are d';
3. All d are b.

4.

1. No b are c;
2. All a are b;
3. No c' are d.

5.

1. All b' are a';
2. No b are c;
3. No a' are d.

6.

1. All a are b';
2. No b' are c;
3. All d are a.

7.

1. No d are b';
2. All b are a;
3. No c are d'.

8.

1. No b' are d;
2. No a' are b;
3. All c are d.

9.

1. All b' are a;
2. No a are d;
3. All b are c.

10.

1. No c are d;
2. All b are c;
3. No a are d'.

pg111

Symbolic Logic

11.

1. No b are c;
2. All d are a;
3. All c' are a'.

12.

1. No c are b';
2. All c' are d';
3. All b are a.

13.

1. All d are e;
2. All c are a;
3. No b are d';
4. All e are a'.

14.

1. All e are b;
2. All a are e;
3. All d are b';
4. All a' are c;

15.

1. No b' are d;
2. All e are c;
3. All b are a;
4. All d' are c'.

16.

1. No a' are e;
2. All d are c';
3. All a are b;
4. All e' are d.

17.

1. All d are c;
2. All a are e;
3. No b are d';
4. All c are e'.

18.

1. All a are b;
2. All d are e;
3. All a' are c';
4. No b are e.

19.

1. No b are c;
2. All e are h;
3. All a are b;
4. No d are h;
5. All e' are c.

20.

1. No d are h';
2. No c are e;
3. All h are b;
4. No a are d';
5. No b are e'.

21.

1. All b are a;
2. No d are h;
3. No c are e;
4. No a are h';
5. All c' are b.

Symbolic Logic

22.

1. All e are d';
2. No b' are h';
3. All c' are d;
4. All a are e;
5. No c are h.

23.

1. All b' are a';
2. No d are e';
3. All h are b';
4. No c are e;
5. All d' are a.

24.

1. All h' are k';
2. No b' are a;
3. All c are d;
4. All e are h';
5. No d are k';
6. No b are c'.

25.

1. All a are d;
2. All k are b;
3. All e are h;
4. No a' are b;
5. All d are c;
6. All h are k.

26.

1. All a' are h;
2. No d' are k';
3. All e are b';
4. No h are k;
5. All a are e;
6. No b' are d.

27.

1. All c are d';
2. No h are b;
3. All a' are k;
4. No c are e';
5. All b' are d;
6. No a are c'.

28.

1. No a' are k;
2. All e are b;
3. No h are k';
4. No d' are c;
5. No a are b;
6. All c' are h.

29.

1. No e are k;
2. No b' are m;
3. No a are c';
4. All h' are e;
5. All d are k;
6. No c are b;
7. All d' are l;
8. No h are m'.

30.

1. All n are m;
2. All a' are e;
3. No c' are l;

Symbolic Logic

4. All k are r';
5. No a are h';
6. No d are l';
7. No c are n';
8. All e are b;
9. All m are r;
10. All h are d.

[N.B. In each Example, in Sections 8 and 9, it is possible to begin with any Premiss, at pleasure, and thus to get as many different Solutions (all of course yielding the same Complete Conclusion) as there are Premisses in the Example. Hence § 8 really contains 129 different Examples, and § 9 contains 273.]

§ 9.

pg112
EX9

Sets of Concrete Propositions, proposed as Premisses for Soriteses: Conclusions to be found.

=1.=

- (1) Babies are illogical;
- (2) Nobody is despised who can manage a crocodile;
- (3) Illogical persons are despised.

Univ. "persons"; a = able to manage a crocodile; b = babies;
c = despised; d = logical.

=2.=

- (1) My saucepans are the only things I have that are made of tin;
- (2) I find all your presents very useful;
- (3) None of my saucepans are of the slightest use.

Univ. "things of mine"; a = made of tin; b = my saucepans; c = useful;
d = your presents.

=3.=

- (1) No potatoes of mine, that are new, have been boiled;
- (2) All my potatoes in this dish are fit to eat;
- (3) No unboiled potatoes of mine are fit to eat.

Univ. "my potatoes"; a = boiled; b = eatable; c = in this dish; d = new.

=4.=

- (1) There are no Jews in the kitchen;
- (2) No Gentiles say "shpoonj";
- (3) My servants are all in the kitchen.

Univ. "persons"; a = in the kitchen; b = Jews; c = my servants;
d = saying "shpoonj."

=5.=

- (1) No ducks waltz;
- (2) No officers ever decline to waltz;

Symbolic Logic

(3) All my poultry are ducks.

Univ. "creatures"; a = ducks; b = my poultry; c = officers; d = willing to waltz.

=6.=

(1) Every one who is sane can do Logic;

(2) No lunatics are fit to serve on a jury;

(3) None of _your_ sons can do Logic.

Univ. "persons"; a = able to do Logic; b = fit to serve on a jury; c = sane; d = your sons.

pg113

=7.=

(1) There are no pencils of mine in this box;

(2) No sugar-plums of mine are cigars;

(3) The whole of my property, that is not in this box, consists of cigars.

Univ. "things of mine"; a = cigars; b = in this box; c = pencils; d = sugar-plums.

=8.=

(1) No experienced person is incompetent;

(2) Jenkins is always blundering;

(3) No competent person is always blundering.

Univ. "persons"; a = always blundering; b = competent; c = experienced; d = Jenkins.

=9.=

(1) No terriers wander among the signs of the zodiac;

(2) Nothing, that does not wander among the signs of the zodiac, is a comet;

(3) Nothing but a terrier has a curly tail.

Univ. "things"; a = comets; b = curly-tailed; c = terriers; d = wandering among the signs of the zodiac.

=10.=

(1) No one takes in the _Times_, unless he is well-educated;

(2) No hedge-hogs can read;

(3) Those who cannot read are not well-educated.

Univ. "creatures"; a = able to read; b = hedge-hogs; c = taking in the Times; d = well-educated.

=11.=

(1) All puddings are nice;

(2) This dish is a pudding;

Symbolic Logic

(3) No nice things are wholesome.

Univ. "things"; a = nice; b = puddings; c = this dish; d = wholesome.

=12.=

(1) My gardener is well worth listening to on military subjects;

(2) No one can remember the battle of Waterloo, unless he is very old;

(3) Nobody is really worth listening to on military subjects, unless he can remember the battle of Waterloo.

Univ. "persons"; a = able to remember the battle of Waterloo; b = my gardener; c = well worth listening to on military subjects; d = very old.

pg114

=13.=

(1) All humming-birds are richly coloured;

(2) No large birds live on honey;

(3) Birds that do not live on honey are dull in colour.

Univ. "birds"; a = humming-birds; b = large; c = living on honey; d = richly coloured.

=14.=

(1) No Gentiles have hooked noses;

(2) A man who is a good hand at a bargain always makes money;

(3) No Jew is ever a bad hand at a bargain.

Univ. "persons"; a = good hands at a bargain; b = hook-nosed; c = Jews; d = making money.

=15.=

(1) All ducks in this village, that are branded 'B,' belong to Mrs. Bond;

(2) Ducks in this village never wear lace collars, unless they are branded 'B';

(3) Mrs. Bond has no gray ducks in this village.

Univ. "ducks in this village"; a = belonging to Mrs. Bond; b = branded 'B'; c = gray; d = wearing lace-collars.

=16.=

(1) All the old articles in this cupboard are cracked;

(2) No jug in this cupboard is new;

(3) Nothing in this cupboard, that is cracked, will hold water.

Univ. "things in this cupboard"; a = able to hold water; b = cracked; c = jugs; d = old.

=17.=

(1) All unripe fruit is unwholesome;

Symbolic Logic

- (2) All these apples are wholesome;
- (3) No fruit, grown in the shade, is ripe.

Univ. "fruit"; a = grown in the shade; b = ripe; c = these apples;
d = wholesome.

=18.=

- (1) Puppies, that will not lie still, are always grateful for the loan of a skipping-rope;
- (2) A lame puppy would not say "thank you" if you offered to lend it a skipping-rope.
- (3) None but lame puppies ever care to do worsted-work.

Univ. "puppies"; a = caring to do worsted-work; b = grateful for the loan of a skipping-rope; c = lame; d = willing to lie still.

pg115

=19.=

- (1) No name in this list is unsuitable for the hero of a romance;
- (2) Names beginning with a vowel are always melodious;
- (3) No name is suitable for the hero of a romance, if it begins with a consonant.

Univ. "names"; a = beginning with a vowel; b = in this list;
c = melodious; d = suitable for the hero of a romance.

=20.=

- (1) All members of the House of Commons have perfect self-command;
- (2) No M.P., who wears a coronet, should ride in a donkey-race;
- (3) All members of the House of Lords wear coronets.

Univ. "M.P.'s"; a = belonging to the House of Commons; b = having perfect self-command; c = one who may ride in a donkey-race; d = wearing a coronet.

=21.=

- (1) No goods in this shop, that have been bought and paid for, are still on sale;
- (2) None of the goods may be carried away, unless labeled "sold";
- (3) None of the goods are labeled "sold," unless they have been bought and paid for.

Univ. "goods in this shop"; a = allowed to be carried away; b = bought and paid for; c = labeled "sold"; d = on sale.

=22.=

- (1) No acrobatic feats, that are not announced in the bills of a circus, are ever attempted there;
- (2) No acrobatic feat is possible, if it involves turning a quadruple somersault;
- (3) No impossible acrobatic feat is ever announced in a circus bill.

Univ. "acrobatic feats"; a = announced in the bills of a circus;

Symbolic Logic

b = attempted in a circus; c = involving the turning of a quadruple somersault; d = possible.

=23.=

- (1) Nobody, who really appreciates Beethoven, fails to keep silence while the Moonlight-Sonata is being played;
- (2) Guinea-pigs are hopelessly ignorant of music;
- (3) No one, who is hopelessly ignorant of music, ever keeps silence while the Moonlight-Sonata is being played.

Univ. "creatures"; a = guinea-pigs; b = hopelessly ignorant of music; c = keeping silence while the Moonlight-Sonata is being played; d = really appreciating Beethoven.

pg116

=24.=

- (1) Coloured flowers are always scented;
- (2) I dislike flowers that are not grown in the open air;
- (3) No flowers grown in the open air are colourless.

Univ. "flowers"; a = coloured; b = grown in the open air; c = liked by me; d = scented.

=25.=

- (1) Showy talkers think too much of themselves;
- (2) No really well-informed people are bad company;
- (3) People who think too much of themselves are not good company.

Univ. "persons"; a = good company; b = really well-informed; c = showy talkers; d = thinking too much of one's self.

=26.=

- (1) No boys under 12 are admitted to this school as boarders;
- (2) All the industrious boys have red hair;
- (3) None of the day-boys learn Greek;
- (4) None but those under 12 are idle.

Univ. "boys in this school"; a = boarders; b = industrious; c = learning Greek; d = red-haired; e = under 12.

=27.=

- (1) The only articles of food, that my doctor allows me, are such as are not very rich;
- (2) Nothing that agrees with me is unsuitable for supper;
- (3) wedding-cake is always very rich;
- (4) My doctor allows me all articles of food that are suitable for supper.

Univ. "articles of food"; a = agreeing with me; b = allowed by my doctor; c = suitable for supper; d = very rich; e = wedding-cake.

=28.=

Symbolic Logic

- (1) No discussions in our Debating-Club are likely to rouse the British Lion, so long as they are checked when they become too noisy;
- (2) Discussions, unwisely conducted, endanger the peacefulness of our Debating-Club;
- (3) Discussions, that go on while Tomkins is in the Chair, are likely to rouse the British Lion;
- (4) Discussions in our Debating-Club, when wisely conducted, are always checked when they become too noisy.

Univ. "discussions in our Debating-Club"; a = checked when too noisy; b = dangerous to the peacefulness of our Debating-Club; c = going on while Tomkins is in the chair; d = likely to rouse the British Lion; e = wisely conducted.

pg117

=29.=

- (1) All my sons are slim;
- (2) No child of mine is healthy who takes no exercise;
- (3) All gluttons, who are children of mine, are fat;
- (4) No daughter of mine takes any exercise.

Univ. "my children"; a = fat; b = gluttons; c = healthy; d = sons; e = taking exercise.

=30.=

- (1) Things sold in the street are of no great value;
- (2) Nothing but rubbish can be had for a song;
- (3) Eggs of the Great Auk are very valuable;
- (4) It is only what is sold in the street that is really _rubbish_.

Univ. "things"; a = able to be had for a song; b = eggs of the Great Auk; c = rubbish; d = sold in the street; e = very valuable.

=31.=

- (1) No books sold here have gilt edges, except what are in the front shop;
- (2) All the _authorised_ editions have red labels;
- (3) All the books with red labels are priced at 5s. and upwards;
- (4) None but _authorised_ editions are ever placed in the front shop.

Univ. "books sold here"; a = authorised editions; b = gilt-edged; c = having red labels; d = in the front shop; e = priced at 5s. and upwards.

=32.=

- (1) Remedies for bleeding, which fail to check it, are a mockery;
- (2) Tincture of calendula is not to be despised;
- (3) Remedies, which will check the bleeding when you cut your finger, are useful;

Symbolic Logic

(4) All mock remedies for bleeding are despicable.

Univ. "remedies for bleeding"; a = able to check bleeding;
b = despicable; c = mockeries; d = Tincture of Calendula; e = useful
when you cut your finger.

=33.=

- (1) None of the unnoticed things, met with at sea, are mermaids;
- (2) Things entered in the log, as met with at sea, are sure to be worth remembering;
- (3) I have never met with anything worth remembering, when on a voyage;
- (4) Things met with at sea, that are noticed, are sure to be recorded in the log;

Univ. "things met with at sea"; a = entered in log; b = mermaids;
c = met with by me; d = noticed; e = worth remembering.

pg118

=34.=

- (1) The only books in this library, that I do not recommend for reading, are unhealthy in tone;
- (2) The bound books are all well-written;
- (3) All the romances are healthy in tone;
- (4) I do not recommend you to read any of the unbound books.

Univ. "books in this library"; a = bound; b = healthy in tone;
c = recommended by me; d = romances; e = well-written.

=35.=

- (1) No birds, except ostriches, are 9 feet high;
- (2) There are no birds in this aviary that belong to any one but me;
- (3) No ostrich lives on mince-pies;
- (4) I have no birds less than 9 feet high.

Univ. "birds"; a = in this aviary; b = living on mince-pies; c = my;
d = 9 feet high; e = ostriches.

=36.=

- (1) A plum-pudding, that is not really solid, is mere porridge;
- (2) Every plum-pudding, served at my table, has been boiled in a cloth;
- (3) A plum-pudding that is mere porridge is indistinguishable from soup;
- (4) No plum-puddings are really solid, except what are served at my table.

Univ. "plum-puddings"; a = boiled in a cloth; b = distinguishable from
soup; c = mere porridge; d = really solid; e = served at my table.

=37.=

- (1) No interesting poems are unpopular among people of real taste;
- (2) No modern poetry is free from affectation;

Symbolic Logic

- (3) All your poems are on the subject of soap-bubbles;
- (4) No affected poetry is popular among people of real taste;
- (5) No ancient poem is on the subject of soap-bubbles.

Univ. "poems"; a = affected; b = ancient; c = interesting; d = on the subject of soap-bubbles; e = popular among people of real taste; h = written by you.

=38.=

- (1) All the fruit at this Show, that fails to get a prize, is the property of the Committee;
- (2) None of my peaches have got prizes;
- (3) None of the fruit, sold off in the evening, is unripe;
- (4) None of the ripe fruit has been grown in a hot-house;
- (5) All fruit, that belongs to the Committee, is sold off in the evening.

Univ. "fruit at this Show"; a = belonging to the Committee; b = getting prizes; c = grown in a hot-house; d = my peaches; e = ripe; h = sold off in the evening.

pg119

=39.=

- (1) Promise-breakers are untrustworthy;
- (2) Wine-drinkers are very communicative;
- (3) A man who keeps his promises is honest;
- (4) No teetotalers are pawnbrokers;
- (5) One can always trust a very communicative person.

Univ. "persons"; a = honest; b = pawnbrokers; c = promise-breakers; d = trustworthy; e = very communicative; h = wine-drinkers.

=40.=

- (1) No kitten, that loves fish, is unteachable;
- (2) No kitten without a tail will play with a gorilla;
- (3) Kittens with whiskers always love fish;
- (4) No teachable kitten has green eyes;
- (5) No kittens have tails unless they have whiskers.

Univ. "kittens"; a = green-eyed; b = loving fish; c = tailed; d = teachable; e = whiskered; h = willing to play with a gorilla.

=41.=

- (1) All the Eton men in this College play cricket;
- (2) None but the scholars dine at the higher table;
- (3) None of the cricketers row;
- (4) My friends in this College all come from Eton;

Symbolic Logic

(5) All the scholars are rowing-men.

Univ. "men in this college"; a = cricketers; b = dining at the higher table; c = Etonians; d = my friends; e = rowing-men; h = scholars.

=42.=

- (1) There is no box of mine here that I dare open;
- (2) My writing-desk is made of rose-wood;
- (3) All my boxes are painted, except what are here;
- (4) There is no box of mine that I dare not open, unless it is full of live scorpions;
- (5) All my rose-wood boxes are unpainted.

Univ. "my boxes"; a = boxes that I dare open; b = full of live scorpions; c = here; d = made of rose-wood; e = painted; h = writing-desks.

=43.=

- (1) Gentiles have no objection to pork;
- (2) Nobody who admires pigsties ever reads Hogg's poems;
- (3) No Mandarin knows Hebrew;
- (4) Every one, who does not object to pork, admires pigsties;
- (5) No Jew is ignorant of Hebrew.

Univ. "persons"; a = admiring pigsties; b = Jews; c = knowing Hebrew; d = Mandarins; e = objecting to pork; h = reading Hogg's poems.

pg120

=44.=

- (1) All writers, who understand human nature, are clever;
- (2) No one is a true poet unless he can stir the hearts of men;
- (3) Shakespeare wrote "Hamlet";
- (4) No writer, who does not understand human nature, can stir the hearts of men;
- (5) None but a true poet could have written "Hamlet.";

Univ. "writers"; a = able to stir the hearts of men; b = clever; c = Shakespeare; d = true poets; e = understanding human nature; h = writer of 'Hamlet.'

=45.=

- (1) I despise anything that cannot be used as a bridge;
- (2) Everything, that is worth writing an ode to, would be a welcome gift to me;
- (3) A rainbow will not bear the weight of a wheel-barrow;
- (4) Whatever can be used as a bridge will bear the weight of a wheel-barrow;
- (5) I would not take, as a gift, a thing that I despise.

Symbolic Logic

Univ. "things"; a = able to bear the weight of a wheel-barrow;
b = acceptable to me; c = despised by me; d = rainbows; e = useful as a
bridge; h = worth writing an ode to.

=46.=

- (1) When I work a Logic-example without grumbling, you may be sure
it is one that I can understand;
- (2) These Soriteses are not arranged in regular order, like the examples
I am used to;
- (3) No easy example ever make my head ache;
- (4) I ca'n't understand examples that are not arranged in regular order,
like those I am used to;
- (5) I never grumble at an example, unless it gives me a headache.

Univ. "Logic-examples worked by me"; a = arranged in regular order, like
the examples I am used to; b = easy; c = grumbled at by me; d = making
my head ache; e = these Soriteses; h = understood by me.

=47.=

- (1) Every idea of mine, that cannot be expressed as a Syllogism, is
really ridiculous;
- (2) None of my ideas about Bath-buns are worth writing down;
- (3) No idea of mine, that fails to come true, can be expressed as a
Syllogism;
- (4) I never have any really ridiculous idea, that I do not at once refer
to my solicitor;
- (5) My dreams are all about Bath-buns;
- (6) I never refer any idea of mine to my solicitor, unless it is worth
writing down.

Univ. "my ideas"; a = able to be expressed as a Syllogism; b = about
Bath-buns; c = coming true; d = dreams; e = really ridiculous
h = referred to my solicitor; k = worth writing down.

pg121

=48.=

- (1) None of the pictures here, except the battle-pieces, are valuable;
- (2) None of the unframed ones are varnished;
- (3) All the battle-pieces are painted in oils;
- (4) All those that have been sold are valuable;
- (5) All the English ones are varnished;
- (6) All those in frames have been sold.

Univ. "the pictures here"; a = battle-pieces; b = English; c = framed;
d = oil-paintings; e = sold; h = valuable; k = varnished.

=49.=

- (1) Animals, that do not kick, are always unexcitable;
- (2) Donkeys have no horns;

Symbolic Logic

- (3) A buffalo can always toss one over a gate;
- (4) No animals that kick are easy to swallow;
- (5) No hornless animal can toss one over a gate;
- (6) All animals are excitable, except buffaloes.

Univ. "animals"; a = able to toss one over a gate; b = buffaloes;
c = donkeys; d = easy to swallow; e = excitable; h = horned;
k = kicking.

=50.=

- (1) No one, who is going to a party, ever fails to brush his hair;
- (2) No one looks fascinating, if he is untidy;
- (3) Opium-eaters have no self-command;
- (4) Every one, who has brushed his hair, looks fascinating;
- (5) No one wears white kid gloves, unless he is going to a party;
- (6) A man is always untidy, if he has no self-command.

Univ. "persons"; a = going to a party; b = having brushed one's hair;
c = having self-command; d = looking fascinating; e = opium-eaters;
h = tidy; k = wearing white kid gloves.

=51.=

- (1) No husband, who is always giving his wife new dresses, can be a cross-grained man;
- (2) A methodical husband always comes home for his tea;
- (3) No one, who hangs up his hat on the gas-jet, can be a man that is kept in proper order by his wife;
- (4) A good husband is always giving his wife new dresses;
- (5) No husband can fail to be cross-grained, if his wife does not keep him in proper order;
- (6) An unmethodical husband always hangs up his hat on the gas-jet.

Univ. "husbands"; a = always coming home for his tea; b = always giving his wife new dresses; c = cross-grained; d = good; e = hanging up his hat on the gas-jet; h = kept in proper order; k = methodical.

pg122

=52.=

- (1) Everything, not absolutely ugly, may be kept in a drawing-room;
- (2) Nothing, that is encrusted with salt, is ever quite dry;
- (3) Nothing should be kept in a drawing-room, unless it is free from damp;
- (4) Bathing-machines are always kept near the sea;
- (5) Nothing, that is made of mother-of-pearl, can be absolutely ugly;
- (6) Whatever is kept near the sea gets encrusted with salt.

Univ. "things"; a = absolutely ugly; b = bathing-machines; c = encrusted

Symbolic Logic

with salt; d = kept near the sea; e = made of mother-of-pearl; h = quite dry; k = things that may be kept in a drawing-room.

=53.=

- (1) I call no day "unlucky," when Robinson is civil to me;
- (2) Wednesdays are always cloudy;
- (3) When people take umbrellas, the day never turns out fine;
- (4) The only days when Robinson is uncivil to me are Wednesdays;
- (5) Everybody takes his umbrella with him when it is raining;
- (6) My "lucky" days always turn out fine.

Univ. "days"; a = called by me 'lucky'; b = cloudy; c = days when people take umbrellas; d = days when Robinson is civil to me; e = rainy; h = turning out fine; k = Wednesdays.

=54.=

- (1) No shark ever doubts that it is well fitted out;
- (2) A fish, that cannot dance a minuet, is contemptible;
- (3) No fish is quite certain that it is well fitted out, unless it has three rows of teeth;
- (4) All fishes, except sharks, are kind to children;
- (5) No heavy fish can dance a minuet;
- (6) A fish with three rows of teeth is not to be despised.

Univ. "fishes"; a = able to dance a minuet; b = certain that he is well fitted out; c = contemptible; d = having 3 rows of teeth; e = heavy; h = kind to children; k = sharks.

=55.=

- (1) All the human race, except my footmen, have a certain amount of common-sense;
- (2) No one, who lives on barley-sugar, can be anything but a mere baby;
- (3) None but a hop-scotch player knows what real happiness is;
- (4) No mere baby has a grain of common sense;
- (5) No engine-driver ever plays hop-scotch;
- (6) No footman of mine is ignorant of what true happiness is.

Univ. "human beings"; a = engine-drivers; b = having common sense; c = hop-scotch players; d = knowing what real happiness is; e = living on barley-sugar; h = mere babies; k = my footmen.

pg123

=56.=

- (1) I trust every animal that belongs to me;
- (2) Dogs gnaw bones;
- (3) I admit no animals into my study, unless they will beg when told to do so;

Symbolic Logic

- (4) All the animals in the yard are mine;
- (5) I admit every animal, that I trust, into my study;
- (6) The only animals, that are really willing to beg when told to do so, are dogs.

Univ. "animals"; a = admitted to my study; b = animals that I trust; c = dogs; d = gnawing bones; e = in the yard; h = my; k = willing to beg when told.

=57.=

- (1) Animals are always mortally offended if I fail to notice them;
- (2) The only animals that belong to me are in that field;
- (3) No animal can guess a conundrum, unless it has been properly trained in a Board-School;
- (4) None of the animals in that field are badgers;
- (5) When an animal is mortally offended, it always rushes about wildly and howls;
- (6) I never notice any animal, unless it belongs to me;
- (7) No animal, that has been properly trained in a Board-School, ever rushes about wildly and howls.

Univ. "animals"; a = able to guess a conundrum; b = badgers; c = in that field; d = mortally offended; e = my; h = noticed by me; k = properly trained in a Board-School; l = rushing about wildly and howling.

=58.=

- (1) I never put a cheque, received by me, on that file, unless I am anxious about it;
- (2) All the cheques received by me, that are not marked with a cross, are payable to bearer;
- (3) None of them are ever brought back to me, unless they have been dishonoured at the Bank;
- (4) All of them, that are marked with a cross, are for amounts of over £100;
- (5) All of them, that are not on that file, are marked "not negotiable";
- (6) No cheque of yours, received by me, has ever been dishonoured;
- (7) I am never anxious about a cheque, received by me, unless it should happen to be brought back to me;
- (8) None of the cheques received by me, that are marked "not negotiable," are for amounts of over £100.

Univ. "cheques received by me"; a = brought back to me; b = cheques that I am anxious about; c = honoured; d = marked with a cross; e = marked 'not negotiable'; h = on that file; k = over £100; l = payable to bearer; m = your.

pg124

=59.=

- (1) All the dated letters in this room are written on blue paper;
- (2) None of them are in black ink, except those that are written in the

Symbolic Logic

third person;

- (3) I have not filed any of them that I can read;
- (4) None of them, that are written on one sheet, are undated;
- (5) All of them, that are not crossed, are in black ink;
- (6) All of them, written by Brown, begin with "Dear Sir";
- (7) All of them, written on blue paper, are filed;
- (8) None of them, written on more than one sheet, are crossed;
- (9) None of them, that begin with "Dear Sir," are written in the third person.

Univ. "letters in this room"; a = beginning with "Dear Sir";
 b = crossed; c = dated; d = filed; e = in black ink; h = in third person;
 k = letters that I can read; l = on blue paper; m = on one sheet;
 n = written by Brown.

=60.=

- (1) The only animals in this house are cats;
- (2) Every animal is suitable for a pet, that loves to gaze at the moon;
- (3) When I detest an animal, I avoid it;
- (4) No animals are carnivorous, unless they prowl at night;
- (5) No cats fails to kill mice;
- (6) No animals ever take to me, except what are in this house;
- (7) Kangaroos are not suitable for pets;
- (8) None but carnivora kill mice;
- (9) I detest animals that do not take to me;
- (10) Animals, that prowl at night, always love to gaze at the moon.

Univ. "animals"; a = avoided by me; b = carnivora; c = cats;
 d = detested by me; e = in this house; h = kangaroos; k = killing mice;
 l = loving to gaze at the moon; m = prowling at night; n = suitable for
 pets; r = taking to me.

pg125

CHAPTER II.

ANSWERS.

Answers to § 1.

AN1

- 1. "All" _Sign of Quantity._
 "persons represented by the Name 'I'" (or "I's") _Subject._
 "are" _Copula._
 "persons who have been out for a walk" _Predicate._

or, more briefly,

"All | 'I's | are | persons who have been out for a walk".

- 2. "All | 'I's | are | persons who feel better".

Symbolic Logic

3. "No | persons who are not 'John' | are | persons who have read the letter".
4. "No | Members of the Class 'you and I' | are | old persons".
5. "No | fat creatures | are | creatures that run well".
6. "No | not-brave persons | are | persons deserving of the fair".
7. "No | not-pale persons | are | persons who look poetical".
8. "Some | judges | are | persons who lose their tempers".
9. "All | 'I's | are | persons who do not neglect important business".
10. "All | difficult things | are | things that need attention".
11. "All | unwholesome things | are | things that should be avoided".
12. "All | laws passed last week | are | laws relating to excise".
13. "All | logical studies | are | things that puzzle me".
14. "No | persons in the house | are | Jews".
15. "Some | not well-cooked dishes | are | unwholesome dishes".
16. "All | unexciting books | are | books that make one drowsy".
17. "All | men who know what they're about | are | men who can detect a sharper".
18. "All | Members of the Class 'you and I' | are | persons who know what they're about".
19. "Some | bald persons | are | persons accustomed to wear wigs".
20. "All | fully occupied persons | are | persons who do not talk about their grievances".
21. "No | riddles that can be solved | are | riddles that interest me".

Answers to § 2.

pg126
AN2

1

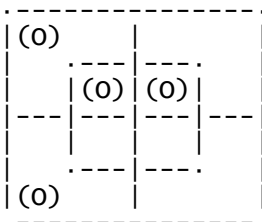

2

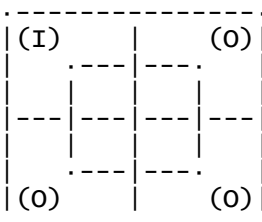

Symbolic Logic

3

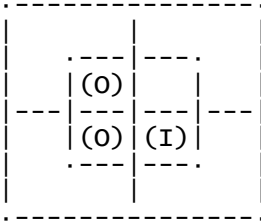

4

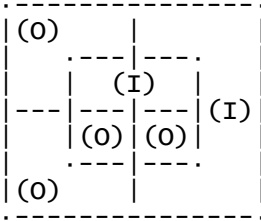

5

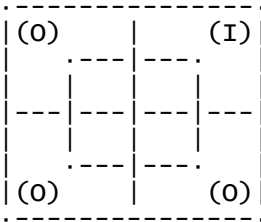

6

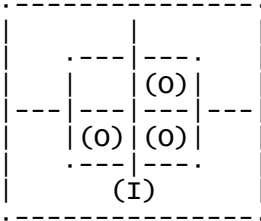

7

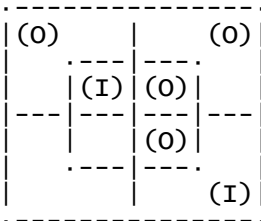

8

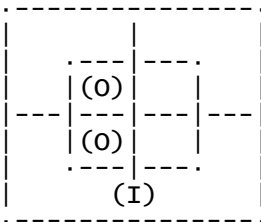

9

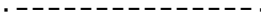

Symbolic Logic

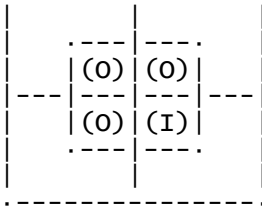

10

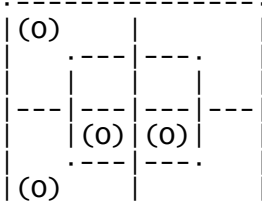

11

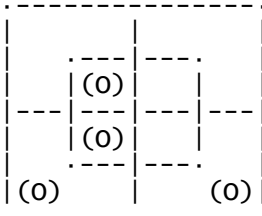

12

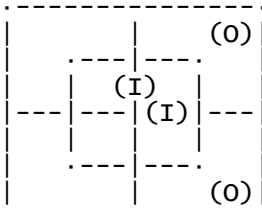

13

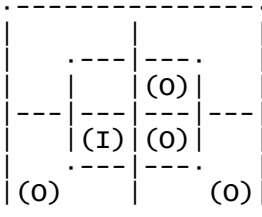

14

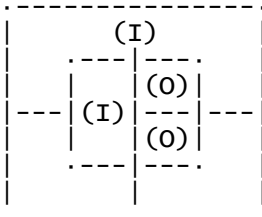

15

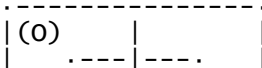

Symbolic Logic

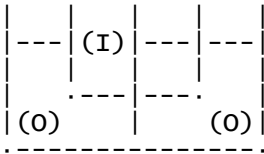

16

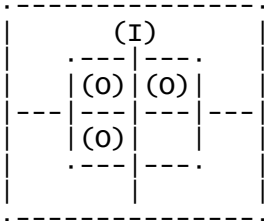

17

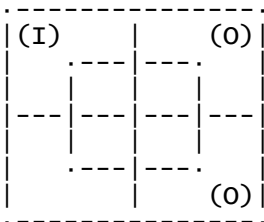

18

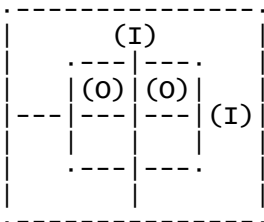

19

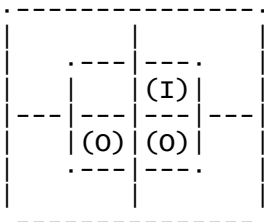

20

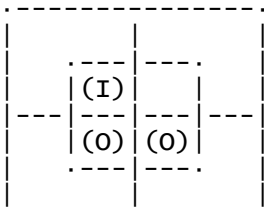

21

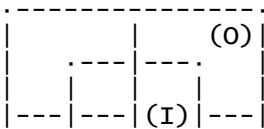

Symbolic Logic

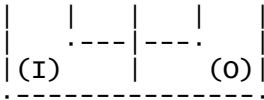

22

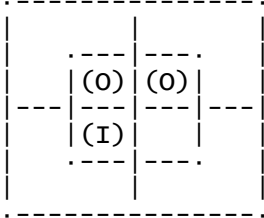

23

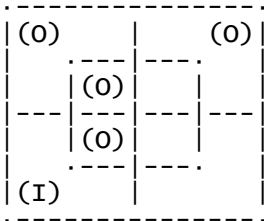

24

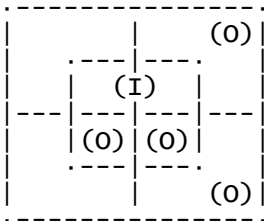

25

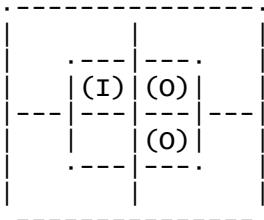

26

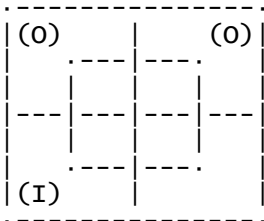

27

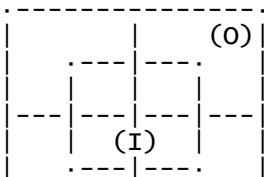

pg127

Symbolic Logic

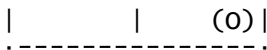

28

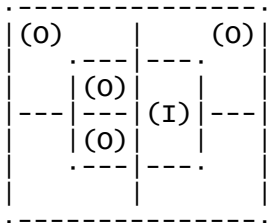

29

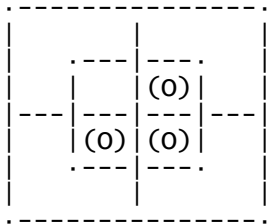

30

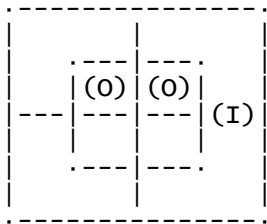

31

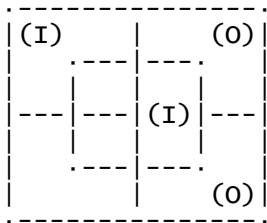

32

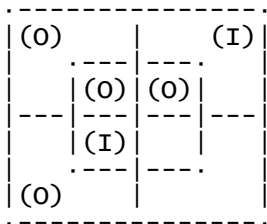

Answers to § 3.

AN3

1. Some xy exist, or some x are y, or some y are x.
2. No information.
3. All y' are x'.
4. No xy exist, &c.

Symbolic Logic

5. All y' are x .
6. All x' are y .
7. All x are y .
8. All x' are y' , and all y are x .
9. All x' are y' .
10. All x are y' .
11. No information.
12. Some $x'y'$ exist, &c.
13. Some xy' exist, &c.
14. No xy' exist, &c.
15. Some xy exist, &c.
16. All y are x .
17. All x' are y , and all y' are x .
18. All x are y' , and all y are x' .
19. All x are y , and all y' are x' .
20. All y are x' .

Answers to § 4.

AN4

1. No x' are y' .
2. Some x' are y' .
3. Some x are y' .
4. [No Concl. Fallacy of Like Eliminands not asserted to exist.]
5. Some x' are y' .
6. [No Concl. Fallacy of Like Eliminands not asserted to exist.]
7. Some x are y' .
8. Some x' are y' .
9. [No Concl. Fallacy of Unlike Eliminands with an Entity-Premiss.]
10. All x are y , and all y' are x' .
11. [No Concl. Fallacy of Like Eliminands not asserted to exist.]
12. All y are x' .
13. No x' are y .
14. No x' are y' .
15. No x are y .
16. All x are y' , and all y are x' .

pg128

Symbolic Logic

17. No x are y'.
18. No x are y.
19. Some x are y'.
20. No x are y'.
21. Some y are x'.
22. [No Concl. Fallacy of Unlike Eliminands with an Entity-Premiss.]
23. Some x are y.
24. All y are x'.
25. Some y are x'.
26. All y are x.
27. All x are y, and all y' are x'.
28. Some y are x'.
29. [No Concl. Fallacy of Like Eliminands not asserted to exist.]
30. Some y are x'.
31. [No Concl. Fallacy of Like Eliminands not asserted to exist.]
32. No x are y'.
33. [No Concl. Fallacy of Like Eliminands not asserted to exist.]
34. Some x are y.
35. All y are x'.
36. Some y are x'.
37. Some x are y'.
38. No x are y.
39. Some x' are y'.
40. All y' are x.
41. All x are y'.
42. No x are y.

Answers to § 5.

AN5

1. Somebody who has been out for a walk is feeling better.
2. No one but John knows what the letter is about.
3. You and I like walking.
4. Honesty is sometimes the best policy.
5. Some greyhounds are not fat.
6. Some brave persons get their deserts.
7. Some rich persons are not Esquimaux.

Symbolic Logic

8. [No Concl. Fallacy of Unlike Eliminands with an Entity-Premiss.]
9. John is ill.
10. Some things, that are not umbrellas, should be left behind on a journey.
11. No music is worth paying for, unless it causes vibration in the air.
12. Some holidays are tiresome.
13. Englishmen are not Frenchmen.
14. No photograph of a lady is satisfactory.
15. No one looks poetical unless he is phlegmatic.
16. Some thin persons are not cheerful.
17. Some judges do not exercise self-control.
18. Pigs are not fed on barley-water.
19. Some black rabbits are not old.
20. [No Concl. Fallacy of Unlike Eliminands with an Entity-Premiss.]^{pg129}
21. [No Concl. Fallacy of Like Eliminands not asserted to exist.]
22. Some lessons need attention.
23. [No Concl. Fallacy of Like Eliminands not asserted to exist.]
24. No one, who forgets a promise, fails to do mischief.
25. Some greedy creatures cannot fly.
26. [No Concl. Fallacy of Unlike Eliminands with an Entity-Premiss.]
27. No bride-cakes are things that need not be avoided.
28. John is happy.
29. Some people, who are not gamblers, are not philosophers.
30. [No Concl. Fallacy of Unlike Eliminands with an Entity-Premiss.]
31. None of my lodgers write poetry.
32. Senna is not nice.
33. [No Concl. Fallacy of Unlike Eliminands with an Entity-Premiss.]
34. [No Concl. Fallacy of Like Eliminands not asserted to exist.]
35. Logic is unintelligible.
36. Some wild creatures are fat.
37. All wasps are unwelcome.
38. All black rabbits are young.
39. Some hard-boiled things can be cracked.
40. No antelopes fail to delight the eye.

Symbolic Logic

41. All well-fed canaries are cheerful.
42. Some poetry is not producible at will.
43. No country infested by dragons fails to be fascinating.
44. [No Concl. Fallacy of Like Eliminands not asserted to exist.]
45. Some picturesque things are not made of sugar.
46. No children can sit still.
47. Some cats cannot whistle.
48. You are terrible.
49. Some oysters are not amusing.
50. Nobody in the house has a beard a yard long.
51. Some ill-fed canaries are unhappy.
52. My sisters cannot sing.
53. [No Concl. Fallacy of Unlike Eliminands with an Entity-Premiss.]
54. Some rich things are nice.
55. My cousins are none of them judges, and judges are none of them cousins of mine.
56. Something wearisome is not eagerly wished for.
57. Senna is nasty.
58. [No Concl. Fallacy of Unlike Eliminands with an Entity-Premiss.]
59. Niggers are not any of them tall.
60. Some obstinate persons are not philosophers.
61. John is happy.
62. Some unwholesome dishes are not present here (i.e. cannot be spoken of as "these").
63. No books suit feverish patients unless they make one drowsy.
64. Some greedy creatures cannot fly.
65. You and I can detect a sharper.
66. Some dreams are not lambs.
67. No lizard needs a hairbrush.
68. Some things, that may escape notice, are not battles.
69. My cousins are not any of them judges.
70. Some hard-boiled things can be cracked.
71. [No Concl. Fallacy of Unlike Eliminands with an Entity-Premiss.]
72. She is unpopular.
73. Some people, who wear wigs, are not children of yours.

pg130

Symbolic Logic

74. No lobsters expect impossibilities.
75. No nightmare is eagerly desired.
76. Some nice things are not plumcakes.
77. Some kinds of jam need not be shunned.
78. All ducks are ungraceful.
79. [No Concl. Fallacy of Like Eliminands not asserted to exist.]
80. No man, who begs in the street, should fail to keep accounts.
81. Some savage creatures are not spiders.
82. [No Concl. Fallacy of Unlike Eliminands with an Entity-Premiss.]
83. No travelers, who do not carry plenty of small change, fail to lose their luggage.
84. [No Concl. Fallacy of Unlike Eliminands with an Entity-Premiss.]
85. Judges are none of them cousins of mine.
86. All my lodgers are sane.
87. Those who are busy are contented, and discontented people are not busy.
88. None of my cousins are judges.
89. No nightingale dislikes sugar.
90. [No Concl. Fallacy of Like Eliminands not asserted to exist.]
91. Some excuses are not clear explanations.
92. [No Concl. Fallacy of Like Eliminands not asserted to exist.]
93. No kind deed need cause scruple.
94. [No Concl. Fallacy of Like Eliminands not asserted to exist.]
95. [No Concl. Fallacy of Like Eliminands not asserted to exist.]
96. No cheats are trustworthy.
97. No clever child of mine is greedy.
98. Some things, that are meant to amuse, are not Acts of Parliament.
99. No tour, that is ever forgotten, is worth writing a book about.
100. No obedient child of mine is contented.
101. Your visit does not annoy me.

Answers to § 6.

AN6

1. Conclusion right.
2. No Concl. Fallacy of Like Eliminands not asserted to exist.
3. Concl. right.

Symbolic Logic

4. Concl. right.
5. Concl. right.
6. No Concl. Fallacy of Like Eliminands not asserted to exist.
7. No Concl. Fallacy of Unlike Eliminands with an Entity-Premiss.
8. Concl. right.
9. Concl. right.
10. Concl. right.
11. Concl. right.
12. Concl. right.
13. Concl. right.
14. Concl. right.
15. Concl. right.
16. No Concl. Fallacy of Like Eliminands not asserted to exist.
17. Concl. right.
18. Concl. right.
19. Concl. right.
20. Concl. right.
21. Concl. right.
22. Concl. wrong: the right one is "Some x are y."
23. Concl. right.
24. Concl. right.
25. Concl. right.
26. Concl. right.
27. Concl. right.
28. No Concl. Fallacy of Like Eliminands not asserted to exist.
29. Concl. right.
30. Concl. right.
31. Concl. right.
32. Concl. right.
33. Concl. right.
34. No Concl. Fallacy of Unlike Eliminands with an Entity-Premiss.
35. Concl. right.
36. Concl. right.
37. Concl. right.

pg131

Symbolic Logic

38. No Concl. Fallacy of Like Eliminands not asserted to exist.
39. Concl. right.
40. Concl. right.

Answers to § 7.

AN7

1. Concl. right.
2. Concl. right.
3. Concl. right.
4. Concl. wrong: right one is "Some epicures are not uncles of mine."
5. Concl. right.
6. No Concl. Fallacy of Unlike Eliminands with an Entity-Premiss.
7. Concl. wrong: right one is "The publication, in which I saw it, tells lies."
8. No Concl. Fallacy of Unlike Eliminands with an Entity-Premiss.
9. Concl. wrong: right one is "Some tedious songs are not his."
10. Concl. right.
11. No Concl. Fallacy of Unlike Eliminands with an Entity-Premiss.
12. Concl. wrong: right one is "Some fierce creatures do not drink coffee."
13. No Concl. Fallacy of Unlike Eliminands with an Entity-Premiss.
14. Concl. right.
15. Concl. wrong: right one is "Some shallow persons are not students."
16. No Concl. Fallacy of Like Eliminands not asserted to exist.
17. Concl. wrong: right one is "Some business, other than railways, is unprofitable."
18. Concl. wrong: right one is "Some vain persons are not Professors."
19. Concl. right.
20. Concl. wrong: right one is "Wasps are not puppies."
21. No Concl. Fallacy of Unlike Eliminands with an Entity-Premiss.
22. No Concl. Same Fallacy.
23. Concl. right.
24. Concl. wrong: right one is "Some chocolate-creams are delicious."
25. No Concl. Fallacy of Like Eliminands not asserted to exist.
26. No Concl. Fallacy of Unlike Eliminands with an Entity-Premiss.
27. Concl. wrong: right one is "Some pillows are not pokers."
28. Concl. right.

Symbolic Logic

29. No Concl. Fallacy of Unlike Eliminands with an Entity-Premiss.
30. No Concl. Fallacy of Like Eliminands not asserted to exist.
31. Concl. right.
32. No Concl. Fallacy of Like Eliminands not asserted to exist.
33. No Concl. Fallacy of Unlike Eliminands with an Entity-Premiss. pg132
34. Concl. wrong: right one is "Some dreaded persons are not begged to prolong their visits."
35. Concl. wrong: right one is "No man walks on neither."
36. Concl. right.
37. No Concl. Fallacy of Unlike Eliminands with an Entity-Premiss.
38. Concl. wrong: right one is "Some persons, dreaded by children, are not emperors."
39. Concl. incomplete: the omitted portion is "Sugar is not salt."
40. Concl. right.

Answers to § 8.

AN8

1. $a_{1}b_{0} + b_{1}a_{0}$.
2. $d_{1}a_{0}$.
3. ac_{0} .
4. $a_{1}d_{0}$.
5. cd_{0} .
6. $d_{1}c_{0}$.
7. $a'c_{0}$.
8. $c_{1}a'_{0}$.
9. $c'd_{0}$.
10. $b_{1}a_{0}$.
11. $d_{1}b_{0}$.
12. $a'd_{0}$.
13. $e_{1}b_{0}$.
14. $d_{1}e'_{0}$.
15. $e_{1}a'_{0}$.
16. $b'c_{0}$.
17. $a_{1}b_{0}$.
18. $d_{1}c_{0}$.
19. $a_{1}d_{0}$.
20. ac_{0} .

Symbolic Logic

21. $de_{\{0\}}$.
22. $a_{\{1\}}b'_{\{0\}}$.
23. $h_{\{1\}}c_{\{0\}}$.
24. $e_{\{1\}}a_{\{0\}}$.
25. $e_{\{1\}}c'_{\{0\}}$.
26. $e_{\{1\}}c'_{\{0\}}$.
27. $hk'_{\{0\}}$.
28. $e_{\{1\}}d'_{\{0\}}$.
29. $l'a_{\{0\}}$.
30. $k_{\{1\}}b'_{\{0\}}$.

Answers to § 9.

AN9

1. Babies cannot manage crocodiles.
2. Your presents to me are not made of tin.
3. All my potatoes in this dish are old ones.
4. My servants never say "shpoonj."
5. My poultry are not officers.
6. None of your sons are fit to serve on a jury.
7. No pencils of mine are sugar-plums.
8. Jenkins is inexperienced.
9. No comet has a curly tail.
10. No hedge-hog takes in the Times.
11. This dish is unwholesome.
12. My gardener is very old.
13. All humming-birds are small.
14. No one with a hooked nose ever fails to make money.
15. No gray ducks in this village wear lace collars.
16. No jug in this cupboard will hold water.
17. These apples were grown in the sun.
18. Puppies, that will not lie still, never care to do worsted work.
19. No name in this list is unmelodious.
20. No M.P. should ride in a donkey-race, unless he has perfect self-command.
21. No goods in this shop, that are still on sale, may be carried away.
22. No acrobatic feat, which involves turning a quadruple somersault, is

Symbolic Logic

ever attempted in a circus.

23. Guinea-pigs never really appreciate Beethoven.
24. No scentless flowers please me.
25. Showy talkers are not really well-informed.
26. None but red-haired boys learn Greek in this school.
27. wedding-cake always disagrees with me.
28. Discussions, that go on while Tomkins is in the chair, endanger the peacefulness of our Debating-Club.
29. All gluttons, who are children of mine, are unhealthy.
30. An egg of the Great Auk is not to be had for a song.
31. No books sold here have gilt edges, unless they are priced at 5s. and upwards.
32. When you cut your finger, you will find Tincture of Calendula useful.
33. I have never come across a mermaid at sea.
34. All the romances in this library are well-written.
35. No bird in this aviary lives on mince-pies.
36. No plum-pudding, that has not been boiled in a cloth, can be distinguished from soup.
37. All your poems are uninteresting.
38. None of my peaches have been grown in a hot-house.
39. No pawnbroker is dishonest.
40. No kitten with green eyes will play with a gorilla.
41. All my friends dine at the lower table.
42. My writing-desk is full of live scorpions.
43. No Mandarin ever reads Hogg's poems.
44. Shakespeare was clever.
45. Rainbows are not worth writing odes to.
46. These Sorites-examples are difficult.
47. All my dreams come true.
48. All the English pictures here are painted in oils.
49. Donkeys are not easy to swallow.
50. Opium-eaters never wear white kid gloves.
51. A good husband always comes home for his tea.
52. Bathing-machines are never made of mother-of-pearl.
53. Rainy days are always cloudy.

Symbolic Logic

54. No heavy fish is unkind to children.
55. No engine-driver lives on barley-sugar.
56. All the animals in the yard gnaw bones.
57. No badger can guess a conundrum.
58. No cheque of yours, received by me, is payable to order.
59. I cannot read any of Brown's letters.
60. I always avoid a kangaroo.

pg134

CHAPTER III.

SOLUTIONS.

§ 1.

Propositions of Relation reduced to normal form.

Solutions for § 1.

SL1

1. The Univ. is "persons." The Individual "I" may be regarded as a Class, of persons, whose peculiar Attribute is "represented by the Name 'I'", and may be called the Class of "I's". It is evident that this Class cannot possibly contain more than one Member: hence the Sign of Quantity is "all". The verb "have been" may be replaced by the phrase "are persons who have been". The Proposition may be written thus:--

"All"	_Sign of Quantity_.
"I's"	_Subject_.
"are"	_Copula_.
"persons who have been out for a walk"	_Predicate_.

or, more briefly,

"All | I's | are | persons who have been out for a walk".

2. The Univ. and the Subject are the same as in Ex. 1. The Proposition may be written

"All | I's | are | persons who feel better".

3. Univ. is "persons". The Subject is evidently the Class of persons from which John is excluded; i.e. it is the Class containing all persons who are not "John".

The Sign of Quantity is "no".

The verb "has read" may be replaced by the phrase "are persons who have read".

The Proposition may be written

"No | persons who are not 'John' | are | persons who have read the letter".

4. Univ. is "persons". The Subject is evidently the Class of persons whose only two Members are "you and I".

Hence the Sign of Quantity is "no".

Symbolic Logic

The Proposition may be written

"No | Members of the Class 'you and I' | are | old persons".

pg135

5. Univ. is "creatures". The verb "run well" may be replaced by the phrase "are creatures that run well".

The Proposition may be written

"No | fat creatures | are | creatures that run well".

6. Univ. is "persons". The Subject is evidently the Class of persons who are not brave.

The verb "deserve" may be replaced by the phrase "are deserving of".

The Proposition may be written

"No | not-brave persons | are | persons deserving of the fair".

7. Univ. is "persons". The phrase "looks poetical" evidently belongs to the Predicate; and the Subject is the Class, of persons, whose peculiar Attribute is "not-pale".

The Proposition may be written

"No | not-pale persons | are | persons who look poetical".

8. Univ. is "persons".

The Proposition may be written

"Some | judges | are | persons who lose their tempers".

9. Univ. is "persons". The phrase "never neglect" is merely a stronger form of the phrase "am a person who does not neglect".

The Proposition may be written

"All | 'I's' | are | persons who do not neglect important business".

10. Univ. is "things". The phrase "what is difficult" (i.e. "that which is difficult") is equivalent to the phrase "all difficult things".

The Proposition may be written

"All | difficult things | are | things that need attention".

11. Univ. is "things". The phrase "what is unwholesome" may be interpreted as in Ex. 10.

The Proposition may be written

"All | unwholesome things | are | things that should be avoided".

12. Univ. is "laws". The Predicate is evidently a Class whose peculiar Attribute is "relating to excise".

The Proposition may be written

"All | laws passed last week | are | laws relating to excise".

13. Univ. is "things". The Subject is evidently the Class, of studies, whose peculiar Attribute is "logical"; hence the Sign of Quantity is "all".

The Proposition may be written

Symbolic Logic

"All | logical studies | are | things that puzzle me".

14. Univ. is "persons". The Subject is evidently "persons in the house".

The Proposition may be written

"No | persons in the house | are | Jews".

15. Univ. is "dishes". The phrase "if not well-cooked" is equivalent to the Attribute "not well-cooked".

The Proposition may be written

"Some | not well-cooked dishes | are | unwholesome dishes".

16. Univ. is "books". The phrase "make one drowsy" may be replaced by the phrase "are books that make one drowsy". pg136

The Sign of Quantity is evidently "all".

The Proposition may be written

"All | unexciting books | are | books that make one drowsy".

17. Univ. is "men". The Subject is evidently "a man who knows what he's about"; and the word "when" shows that the Proposition is asserted of every such man, i.e. of all such men. The verb "can" may be replaced by "are men who can".

The Proposition may be written

"All | men who know what they're about | are | men who can detect a sharper".

18. The Univ. and the Subject are the same as in Ex. 4.

The Proposition may be written

"All | Members of the Class 'you and I' | are | persons who know what they're about".

19. Univ. is "persons". The verb "wear" may be replaced by the phrase "are accustomed to wear".

The Proposition may be written

"Some | bald persons | are | persons accustomed to wear wigs".

20. Univ. is "persons". The phrase "never talk" is merely a stronger form of "are persons who do not talk".

The Proposition may be written

"All | fully occupied persons | are | persons who do not talk about their grievances".

21. Univ. is "riddles". The phrase "if they can be solved" is equivalent to the Attribute "that can be solved".

The Proposition may be written

"No | riddles that can be solved | are | riddles that interest me".

§ 2.

Method of Diagrams.

Symbolic Logic

Solutions for § 4, Nos. 1-12.

SL4-A

1. No m are x';
All m' are y'.

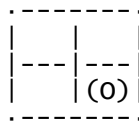
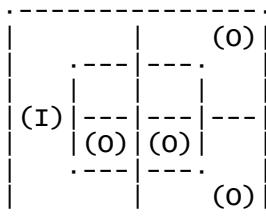

∴ No x' are y'.

2. No m' are x;
Some m' are y'.

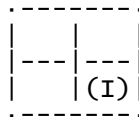
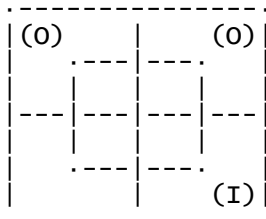

∴ Some x are y'.

3. All m' are x;
All m' are y'.

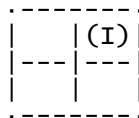
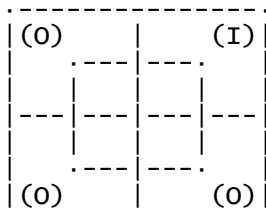

∴ Some x are y'.

4. No x' are m';
All y' are m.

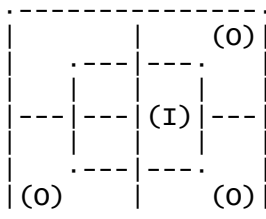

There is no Conclusion.

5. Some m are x';
No y are m.

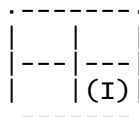
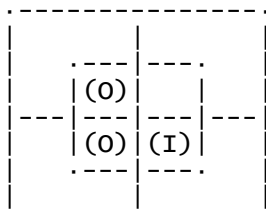

∴ Some x' are y'.

6. No x' are m;
No m are y.

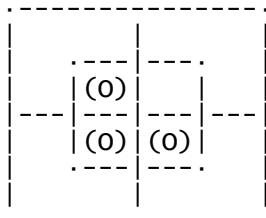

There is no Conclusion.

7. No m are x';
Some y' are m.

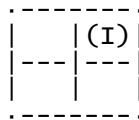
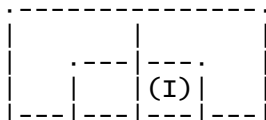

pg137

Symbolic Logic

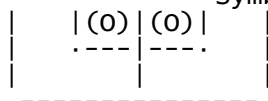

∴ Some x are y'.

8. All m' are x';
No m' are y'.

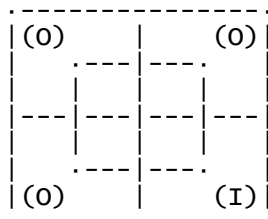

∴ Some x' are y'.

pg138

9. Some x' are m';
No m are y'.

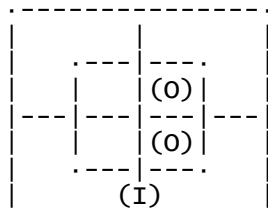

There is no Conclusion.

10. All x are m;
All y' are m'.

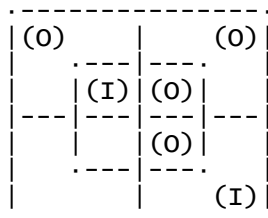

∴ All x are y;
All y' are x'.

11. No m are x;
All y' are m'.

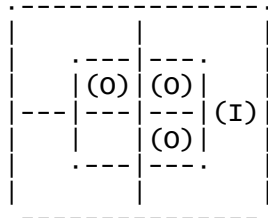

There is no Conclusion.

12. No x are m;
All y are m.

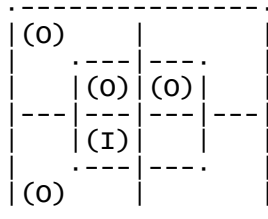

∴ All y are x'.

Solutions for § 5, Nos. 1-12.

SL5-A

1. I have been out for a walk;
I am feeling better.

Univ. is "persons"; m = the Class of I's; x = persons who have been out for a walk; y = persons who are feeling better.

All m are x;
All m are y.

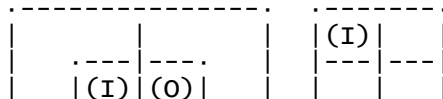

Symbolic Logic

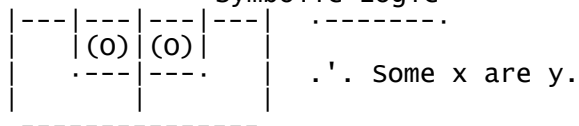

i.e. Somebody, who has been out for a walk, is feeling better.

pg139

2. No one has read the letter but John;
No one, who has not read it, knows what it is about.

Univ. is "persons"; m = persons who have read the letter; x = the Class of Johns; y = persons who know what the letter is about.

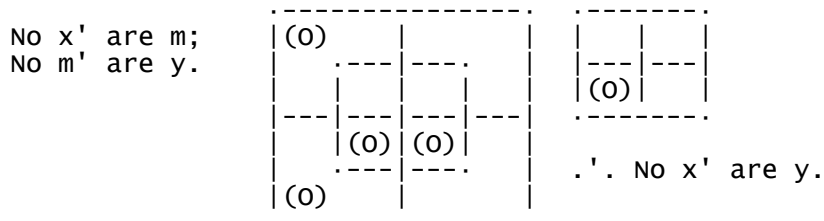

i.e. No one, but John, knows what the letter is about.

3. Those who are not old like walking;
You and I are young.

Univ. is "persons"; m = old; x = persons who like walking; y = you and I.

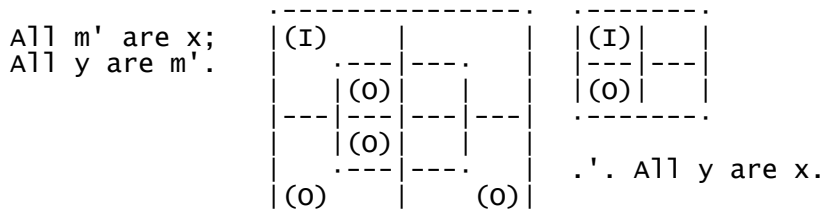

i.e. You and I like walking.

4. Your course is always honest;
Your course is always the best policy.

Univ. is "courses"; m = your; x = honest; y = courses which are the best policy.

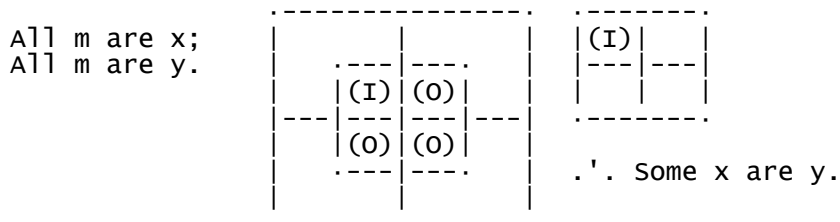

i.e. Honesty is sometimes the best policy.

5. No fat creatures run well;
Some greyhounds run well.

Univ. is "creatures"; m = creatures that run well; x = fat; y = greyhounds.

Symbolic Logic

No x are m;
Some y are m.

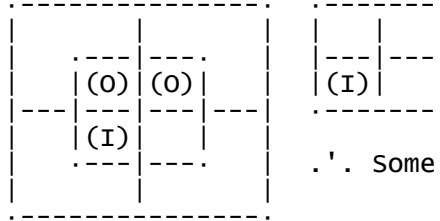

.'. Some y are x'.

i.e. Some greyhounds are not fat.

pg140

6. Some, who deserve the fair, get their deserts;
None but the brave deserve the fair.

Univ. is "persons"; m = persons who deserve the fair; x = persons who get their deserts; y = brave.

Some m are x;
No y' are m.

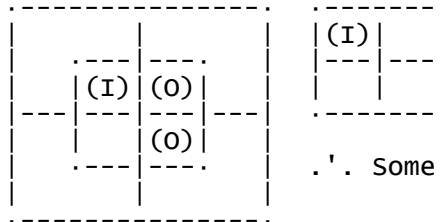

.'. Some y are x.

i.e. Some brave persons get their deserts.

7. Some Jews are rich;
All Esquimaux are Gentiles.

Univ. is "persons"; m = Jews; x = rich; y = Esquimaux.

Some m are x;
All y are m'.

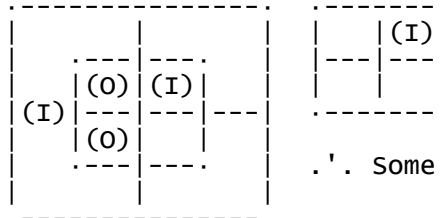

.'. Some x are y'.

i.e. Some rich persons are not Esquimaux.

8. Sugar-plums are sweet;
Some sweet things are liked by children.

Univ. is "things"; m = sweet; x = sugar-plums; y = things that are liked by children.

All x are m;
Some m are y.

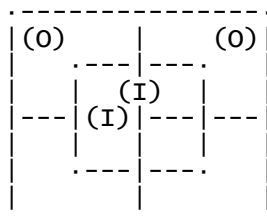

There is no conclusion.

9. John is in the house;
Everybody in the house is ill.

Symbolic Logic

Univ. is "persons"; m = persons in the house; x = the class of Johns;
y = ill.

All x are m;
All m are y.

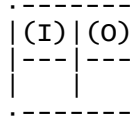
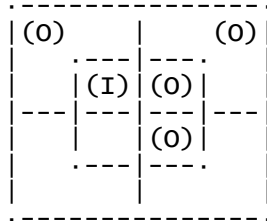

.'. All x are y.

i.e. John is ill.

pg141

10. Umbrellas are useful on a journey;
What is useless on a journey should be left behind.

Univ. is "things"; m = useful on a journey; x = umbrellas; y = things
that should be left behind.

All x are m;
All m' are y.

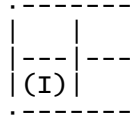
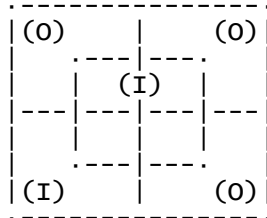

.'. Some x' are y.

i.e. Some things, that are not umbrellas, should be left behind on a
journey.

11. Audible music causes vibration in the air;
Inaudible music is not worth paying for.

Univ. is "music"; m = audible; x = music that causes vibration in the
air; y = worth paying for.

All m are x;
All m' are y'.

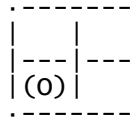
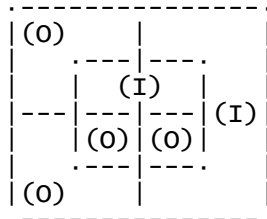

.'. No x' are y.

i.e. No music is worth paying for, unless it causes vibration in the
air.

12. Some holidays are rainy;
Rainy days are tiresome.

Univ. is "days"; m = rainy; x = holidays; y = tiresome.

Some x are m;
All m are y.

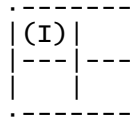
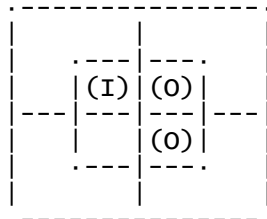

.'. Some x are y.

i.e. Some holidays are tiresome.

Solutions for § 6, Nos. 1-10.

SL6-A

1.

Some x are m; No m are y'. Some x are y.

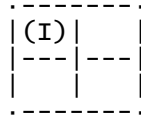
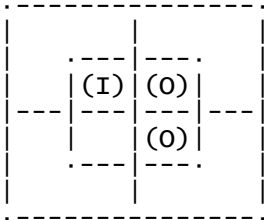

Hence proposed Conclusion is right.

pg142

2.

All x are m; No y are m'. No y are x'.

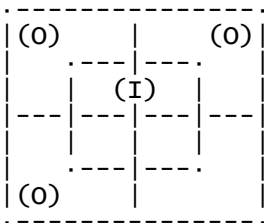

There is no Conclusion.

3.

Some x are m'; All y' are m. Some x are y.

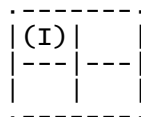
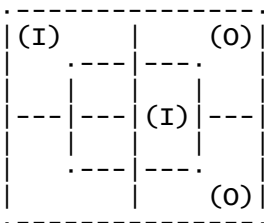

Hence proposed Conclusion is right.

4.

All x are m; No y are m. All x are y'.

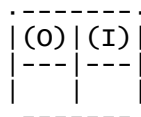
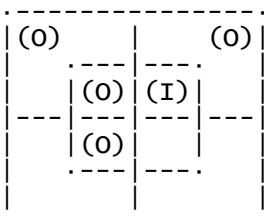

Hence proposed Conclusion is right.

5.

Some m' are x'; No m' are y. Some x' are y'.

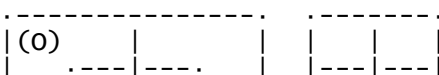

Symbolic Logic

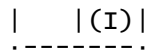
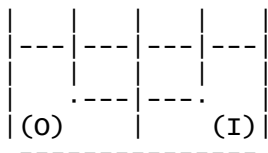

Hence proposed Conclusion is right.

6.

No x' are m; All y are m'. All y are x.

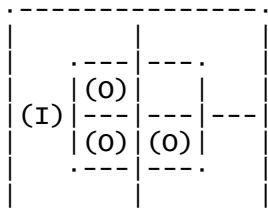

There is no Conclusion.

7.

Some m' are x'; All y' are m'. Some x' are y'.

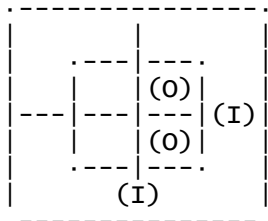

There is no Conclusion.

pg143

8.

No m' are x'; All y' are m'. All y' are x.

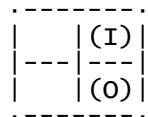
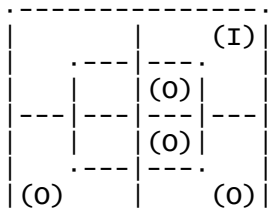

Hence proposed Conclusion is right.

9.

Some m are x'; No m are y. Some x' are y'.

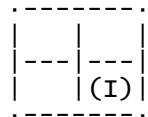
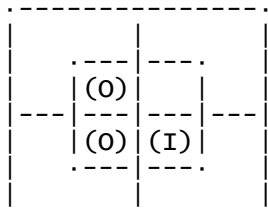

Hence proposed Conclusion is right.

10.

All m' are x'; All m are y. Some y are x'.

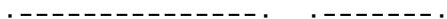

Symbolic Logic

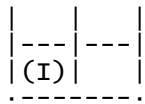
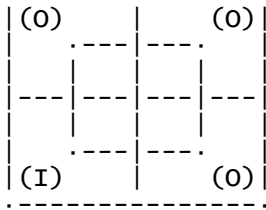

Hence proposed Conclusion is right.

Solutions for § 7, Nos. 1-6.

pg144
SL7-A

1.

No doctors are enthusiastic;
You are enthusiastic.
You are not a doctor.

Univ. "persons"; m = enthusiastic; x = doctors; y = you.

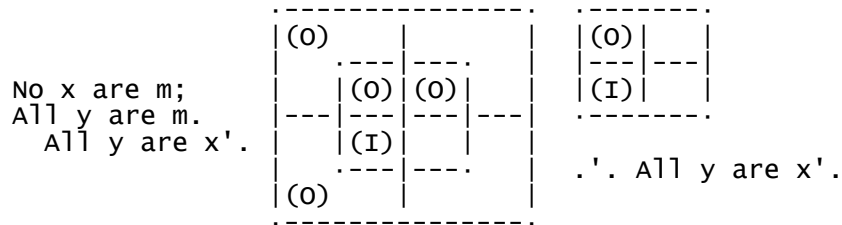

Hence proposed Conclusion is right.

2.

All dictionaries are useful;
Useful books are valuable.
Dictionaries are valuable.

Univ. "books"; m = useful; x = dictionaries; y = valuable.

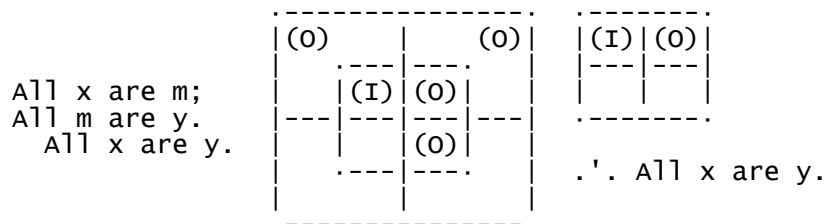

Hence proposed Conclusion is right.

3.

No misers are unselfish;
None but misers save egg-shells.
No unselfish people save egg-shells.

Univ. "people"; m = misers; x = selfish; y = people who save egg-shells.

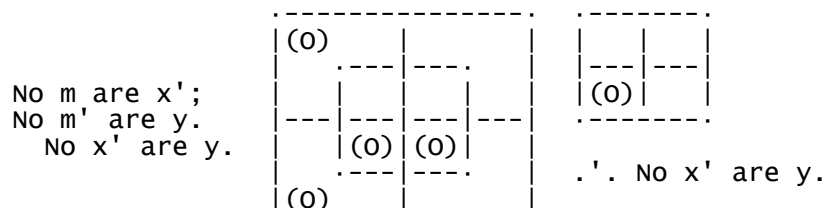

Symbolic Logic

Hence proposed Conclusion is right.

pg145

4.

Some epicures are ungenerous;
 All my uncles are generous.
 My uncles are not epicures.

Univ. "persons"; m = generous; x = epicures; y = my uncles.

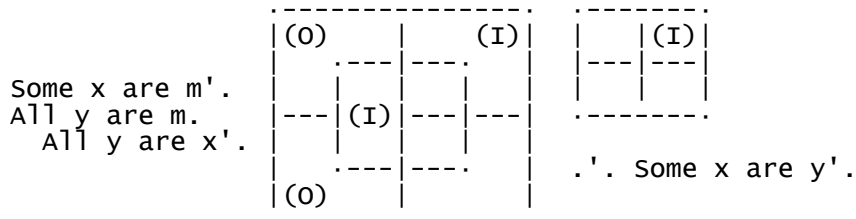

Hence proposed Conclusion is wrong, the right one being "Some epicures are not uncles of mine."

5.

Gold is heavy;
 Nothing but gold will silence him.
 Nothing light will silence him.

Univ. "things"; m = gold; x = heavy; y = able to silence him.

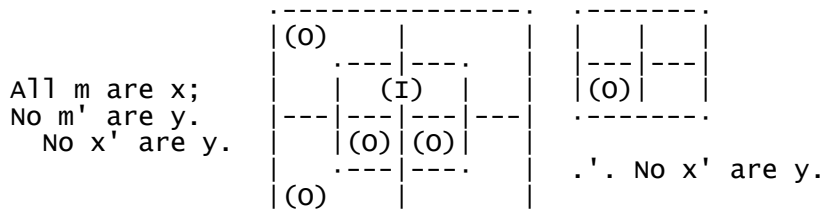

Hence proposed Conclusion is right.

6.

Some healthy people are fat;
 No unhealthy people are strong.
 Some fat people are not strong.

Univ. "persons"; m = healthy; x = fat; y = strong.

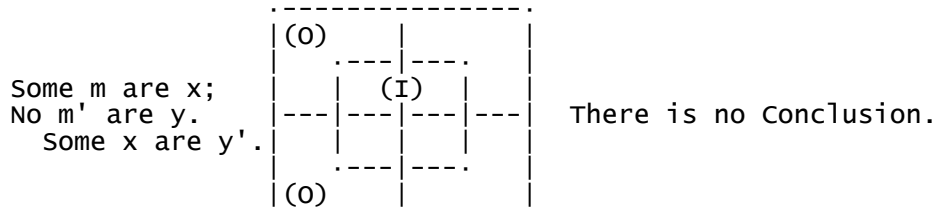

pg146

§ 3.

Method of Subscripts.

Symbolic Logic

solutions for § 4.

SL4-B

1. $mx'_{\{0\}} + m'_{\{1\}}y'_{\{0\}} \nVdash x'y'_{\{0\}}$ [Fig. I.
i.e. "No x' are y'."
2. $m'x_{\{0\}} + m'y'_{\{1\}} \nVdash x'y'_{\{1\}}$ [Fig. II.
i.e. "Some x' are y'."
3. $m'_{\{1\}}x'_{\{0\}} + m'_{\{1\}}y_{\{0\}} \nVdash xy'_{\{1\}}$ [Fig. III.
i.e. "Some x are y'."
4. $x'm'_{\{0\}} + y'_{\{1\}}m'_{\{0\}} \nVdash$ nothing.
[Fallacy of Like Eliminands
not asserted to exist.]
5. $mx'_{\{1\}} + ym_{\{0\}} \nVdash x'y'_{\{1\}}$ [Fig. II.
i.e. "Some x' are y'."
6. $x'm_{\{0\}} + my_{\{0\}} \nVdash$ nothing.
[Fallacy of Like Eliminands
not asserted to exist.]
7. $mx'_{\{0\}} + y'm_{\{1\}} \nVdash xy'_{\{1\}}$ [Fig. II.
i.e. "Some x are y'."
8. $m'_{\{1\}}x_{\{0\}} + m'y_{\{0\}} \nVdash x'y'_{\{1\}}$ [Fig. III.
i.e. "Some x' are y'."
9. $x'm'_{\{1\}} + my_{\{0\}} \nVdash$ nothing.
[Fallacy of Unlike Eliminands
with an Entity-Premiss.]
10. $x_{\{1\}}m'_{\{0\}} + y'_{\{1\}}m_{\{0\}} \nVdash x_{\{1\}}y'_{\{0\}} + y'_{\{1\}}x_{\{0\}}$ [Fig. I (b).
i.e. "All x are y, and all y' are x'."
11. $mx_{\{0\}} + y'_{\{1\}}m_{\{0\}} \nVdash$ nothing.¹
[Fallacy of Like Eliminands
not asserted to exist.]
12. $xm_{\{0\}} + y_{\{1\}}m'_{\{0\}} \nVdash y_{\{1\}}x_{\{0\}}$ [Fig. I (a).
i.e. "All y are x'."
13. $m'_{\{1\}}x'_{\{0\}} + ym_{\{0\}} \nVdash x'y_{\{0\}}$ [Fig. I.
i.e. "No x' are y."
14. $m_{\{1\}}x'_{\{0\}} + m'_{\{1\}}y'_{\{0\}} \nVdash x'y'_{\{0\}}$ [Fig. I.
i.e. "No x' are y'."
15. $xm_{\{0\}} + m'y_{\{0\}} \nVdash xy_{\{0\}}$ [Fig. I.
i.e. "No x are y."
16. $x_{\{1\}}m_{\{0\}} + y_{\{1\}}m'_{\{0\}} \nVdash (x_{\{1\}}y_{\{0\}} + y_{\{1\}}x_{\{0\}})$ [Fig. I (b).
i.e. "All x are y' and all y are x'."
17. $xm_{\{0\}} + m'_{\{1\}}y'_{\{0\}} \nVdash xy'_{\{0\}}$ [Fig. I.
i.e. "No x are y'."
18. $xm'_{\{0\}} + my_{\{0\}} \nVdash xy_{\{0\}}$ [Fig. I.
i.e. "No x are y."
19. $m_{\{1\}}x'_{\{0\}} + m_{\{1\}}y_{\{0\}} \nVdash xy'_{\{1\}}$ [Fig. III.
i.e. "Some x are y'."
20. $mx_{\{0\}} + m'_{\{1\}}y'_{\{0\}} \nVdash xy'_{\{0\}}$ [Fig. I.
i.e. "No x are y'."
21. $x_{\{1\}}m'_{\{0\}} + m'y_{\{1\}} \nVdash x'y_{\{1\}}$ [Fig. II.

Symbolic Logic

i.e. "Some x' are y."

22. $xm_{\{1\}} + y_{\{1\}}m'_{\{0\}} \nRightarrow$ nothing.
[Fallacy of Unlike Eliminands
with an Entity-Premiss.]
23. $m_{\{1\}}x'_{\{0\}} + ym_{\{1\}} \nRightarrow xy_{\{1\}}$ [Fig. II.
i.e. "Some x are y."
24. $xm_{\{0\}} + y_{\{1\}}m'_{\{0\}} \nRightarrow y_{\{1\}}x_{\{0\}}$ [Fig. I (a).
i.e. "All y are x'."
25. $mx'_{\{1\}} + my'_{\{0\}} \nRightarrow x'y_{\{1\}}$ [Fig. II.
i.e. "Some x' are y."
26. $mx'_{\{0\}} + y_{\{1\}}m'_{\{0\}} \nRightarrow y_{\{1\}}x'_{\{0\}}$ [Fig. I (a).
i.e. "All y are x'."
27. $x_{\{1\}}m_{\{0\}} + y'_{\{1\}}m'_{\{0\}} \nRightarrow (x_{\{1\}}y'_{\{0\}} + y'_{\{1\}}x_{\{0\}})$ [Fig. I (b).
i.e. "All x are y, and all y' are x'."
28. $m_{\{1\}}x_{\{0\}} + my_{\{1\}} \nRightarrow x'y_{\{1\}}$ [Fig. II.
i.e. "Some x' are y."
29. $mx_{\{0\}} + y_{\{1\}}m_{\{0\}} \nRightarrow$ nothing.
[Fallacy of Like Eliminands
not asserted to exist.]
30. $x_{\{1\}}m_{\{0\}} + ym_{\{1\}} \nRightarrow x'y_{\{1\}}$ [Fig. II.
i.e. "Some y are x'."
31. $x_{\{1\}}m'_{\{0\}} + y_{\{1\}}m'_{\{0\}} \nRightarrow$ nothing.
[Fallacy of Like Eliminands
not asserted to exist.]
32. $xm'_{\{0\}} + m_{\{1\}}y'_{\{0\}} \nRightarrow xy'_{\{0\}}$ [Fig. I.
i.e. "No x are y'."
33. $mx_{\{0\}} + my_{\{0\}} \nRightarrow$ nothing.
[Fallacy of Like Eliminands
not asserted to exist.]
34. $mx'_{\{0\}} + ym_{\{1\}} \nRightarrow xy_{\{1\}}$ [Fig. II.
i.e. "Some x are y."
35. $mx_{\{0\}} + y_{\{1\}}m'_{\{0\}} \nRightarrow y_{\{1\}}x_{\{0\}}$ [Fig. I (a).
i.e. "All y are x'."
36. $m_{\{1\}}x_{\{0\}} + ym_{\{1\}} \nRightarrow x'y_{\{1\}}$ [Fig. II.
i.e. "Some x' are y."
37. $m_{\{1\}}x'_{\{0\}} + ym_{\{0\}} \nRightarrow xy'_{\{1\}}$ [Fig. III.
i.e. "Some x are y'."
38. $mx_{\{0\}} + m'y_{\{0\}} \nRightarrow xy_{\{0\}}$ [Fig. I.
i.e. "No x are y."
39. $mx'_{\{1\}} + my_{\{0\}} \nRightarrow x'y'_{\{1\}}$ [Fig. II.
i.e. "Some x' are y'."
40. $x'm_{\{0\}} + y'_{\{1\}}m'_{\{0\}} \nRightarrow y'_{\{1\}}x'_{\{0\}}$ [Fig. I (a).
i.e. "All y' are x'."
41. $x_{\{1\}}m_{\{0\}} + ym'_{\{0\}} \nRightarrow x_{\{1\}}y_{\{0\}}$ [Fig. I (a).
i.e. "All x are y'."
42. $m'x_{\{0\}} + ym_{\{0\}} \nRightarrow xy_{\{0\}}$ [Fig. I.
i.e. "No x are y."

pg147

Symbolic Logic

Solutions for § 5, Nos. 13-24.

SL5-B

13. No Frenchmen like plumpudding;
All Englishmen like plumpudding.

Univ. "men"; m = liking plumpudding; x = French; y = English.

$$xm_{\{0\}} + y_{\{1\}}m'_{\{0\}} \nrightarrow y_{\{1\}}x_{\{0\}} \text{ [Fig. I (a).]}$$

i.e. Englishmen are not Frenchmen.

14. No portrait of a lady, that makes her simper or scowl, is
satisfactory;
No photograph of a lady ever fails to make her simper or scowl.

Univ. "portraits of ladies"; m = making the subject simper or scowl;
x = satisfactory; y = photographic.

$$mx_{\{0\}} + ym'_{\{0\}} \nrightarrow xy_{\{0\}} \text{ [Fig. I.]}$$

i.e. No photograph of a lady is satisfactory.

15. All pale people are phlegmatic;
No one looks poetical unless he is pale.

Univ. "people"; m = pale; x = phlegmatic; y = looking poetical.

$$m_{\{1\}}x'_{\{0\}} + m'y_{\{0\}} \nrightarrow x'y_{\{0\}} \text{ [Fig. I.]}$$

i.e. No one looks poetical unless he is phlegmatic.

16. No old misers are cheerful;
Some old misers are thin.

Univ. "persons"; m = old misers; x = cheerful; y = thin.

$$mx_{\{0\}} + my_{\{1\}} \nrightarrow x'y_{\{1\}} \text{ [Fig. II.]}$$

i.e. Some thin persons are not cheerful.

17. No one, who exercises self-control, fails to keep his temper;
Some judges lose their tempers.

Univ. "persons"; m = keeping their tempers; x = exercising self-control;
y = judges.

$$xm'_{\{0\}} + ym'_{\{1\}} \nrightarrow x'y_{\{1\}} \text{ [Fig. II.]}$$

i.e. Some judges do not exercise self-control.

pg148

18. All pigs are fat;
Nothing that is fed on barley-water is fat.

Univ. is "things"; m = fat; x = pigs; y = fed on barley-water.

$$x_{\{1\}}m'_{\{0\}} + ym_{\{0\}} \nrightarrow x_{\{1\}}y_{\{0\}} \text{ [Fig. I (a).]}$$

i.e. Pigs are not fed on barley-water.

19. All rabbits, that are not greedy, are black;
No old rabbits are free from greediness.

Univ. is "rabbits"; m = greedy; x = black; y = old.

$$m'_{\{1\}}x'_{\{0\}} + ym'_{\{0\}} \nrightarrow xy'_{\{1\}} \text{ [Fig. III.]}$$

Symbolic Logic

i.e. Some black rabbits are not old.

20. Some pictures are not first attempts;
No first attempts are really good.

Univ. is "things"; m = first attempts; x = pictures; y = really good.

$xm'_{1} + my_{0}$ \nparallel nothing.

[Fallacy of Unlike Eliminands with an Entity-Premiss.]

21. I never neglect important business;
Your business is unimportant.

Univ. is "business"; m = important; x = neglected by me; y = your.

$mx_{0} + y_{1}m_{0}$ \nparallel nothing.

[Fallacy of Like Eliminands not asserted to exist.]

22. Some lessons are difficult;
What is difficult needs attention.

Univ. is "things"; m = difficult; x = lessons; y = needing attention.

$xm_{1} + m_{1}y'_{0}$ \nparallel xy_{1} [Fig. II.

i.e. Some lessons need attention.

23. All clever people are popular;
All obliging people are popular.

Univ. is "people"; m = popular; x = clever; y = obliging.

$x_{1}m'_{0} + y_{1}m'_{0}$ \nparallel nothing.

[Fallacy of Like Eliminands not asserted to exist.]

24. Thoughtless people do mischief;
No thoughtful person forgets a promise.

Univ. is "persons"; m = thoughtful; x = mischievous; y = forgetful of promises.

$m'_{1}x'_{0} + my_{0}$ \nparallel $x'y_{0}$

i.e. No one, who forgets a promise, fails to do mischief.

Solutions for § 6.

SL6-B

1. $xm_{1} + my'_{0}$ \nparallel xy_{1} [Fig. II.] Concl. right.
2. $x_{1}m'_{0} + ym'_{0}$ Fallacy of Like Eliminands not asserted to exist.
3. $xm'_{1} + y'_{1}m'_{0}$ \nparallel xy_{1} [Fig. II.] Concl. right.
4. $x_{1}m'_{0} + ym_{0}$ \nparallel $x_{1}y_{0}$ [Fig. I (a).] Concl. right. pg149
5. $m'x'_{1} + m'y_{0}$ \nparallel $x'y'_{1}$ [Fig. II.] "
6. $x'm_{0} + y_{1}m_{0}$ Fallacy of Like Eliminands not asserted to exist.
7. $m'x'_{1} + y'_{1}m_{0}$ Fallacy of Unlike Eliminands with an Entity-Premiss.
8. $m'x'_{0} + y'_{1}m_{0}$ \nparallel $y'_{1}x'_{0}$ [Fig. I (a).] Concl. right.

- | | Symbolic | Logic | |
|-----|--|--|---|
| 9. | $mx'_{1} + my_{0} \text{ ¶ } x'y'_{1}$ | [Fig. II.] | " |
| 10. | $m'_{1}x_{0} + m'_{1}y'_{0} \text{ ¶ } x'y_{1}$ | [Fig. III.] | " |
| 11. | $x_{1}m_{0} + ym_{1} \text{ ¶ } x'y_{1}$ | [Fig. II.] | " |
| 12. | $xm_{0} + m'y'_{0} \text{ ¶ } xy'_{0}$ | [Fig. I.] | " |
| 13. | $xm_{0} + y'_{1}m'_{0} \text{ ¶ } y'_{1}x_{0}$ | [Fig. I (a).] | " |
| 14. | $m'_{1}x_{0} + m'_{1}y'_{0} \text{ ¶ } x'y_{1}$ | [Fig. III.] | " |
| 15. | $mx'_{1} + y_{1}m_{0} \text{ ¶ } x'y'_{1}$ | [Fig. II.] | " |
| 16. | $x'm_{0} + y'_{1}m_{0}$ | Fallacy of Like Eliminands not asserted to exist. | |
| 17. | $m'x_{0} + m'_{1}y_{0} \text{ ¶ } x'y'_{1}$ | [Fig. III.] | Concl. right. |
| 18. | $x'm_{0} + my_{1} \text{ ¶ } xy_{1}$ | [Fig. II.] | " |
| 19. | $mx'_{1} + m_{1}y'_{0} \text{ ¶ } x'y_{1}$ | ["] | " |
| 20. | $x'm'_{0} + m'y'_{1} \text{ ¶ } xy'_{1}$ | ["] | " |
| 21. | $mx_{0} + m_{1}y_{0} \text{ ¶ } x'y'_{1}$ | [Fig. III.] | " |
| 22. | $x'_{1}m'_{0} + ym'_{1} \text{ ¶ } xy_{1}$ | [Fig. II.] | Concl. wrong:
the right one is "Some x are y." |
| 23. | $m_{1}x'_{0} + m'y'_{0} \text{ ¶ } x'y'_{0}$ | [Fig. I.] | Concl. right. |
| 24. | $x_{1}m_{0} + m'_{1}y'_{0} \text{ ¶ } x_{1}y'_{0}$ | [Fig. I (a).] | " |
| 25. | $xm'_{0} + m_{1}y'_{0} \text{ ¶ } xy'_{0}$ | [Fig. I.] | " |
| 26. | $m_{1}x_{0} + y_{1}m'_{0} \text{ ¶ } y_{1}x_{0}$ | [Fig. I (a).] | " |
| 27. | $x_{1}m'_{0} + my'_{0} \text{ ¶ } x_{1}y'_{0}$ | ["] | " |
| 28. | $x_{1}m'_{0} + y'm'_{0}$ | Fallacy of Like Eliminands not asserted to exist. | |
| 29. | $x'm_{0} + m'y'_{0} \text{ ¶ } x'y'_{0}$ | [Fig. I.] | Concl. right. |
| 30. | $x_{1}m'_{0} + m_{1}y_{0} \text{ ¶ } x_{1}y_{0}$ | [Fig. I (a).] | " |
| 31. | $x'_{1}m_{0} + y'm'_{0} \text{ ¶ } x'_{1}y'_{0}$ | ["] | " |
| 32. | $xm_{0} + y'm'_{0} \text{ ¶ } xy'_{0}$ | [Fig. I.] | " |
| 33. | $m_{1}x_{0} + y'_{1}m'_{0} \text{ ¶ } y'_{1}x_{0}$ | [Fig. I (a).] | " |
| 34. | $x_{1}m_{0} + ym'_{1}$ | Fallacy of Unlike Eliminands with an Entity-Premiss. | |
| 35. | $xm_{1} + m_{1}y'_{0} \text{ ¶ } xy_{1}$ | [Fig. II.] | Concl. right. |
| 36. | $m_{1}x_{0} + y_{1}m'_{0} \text{ ¶ } y_{1}x_{0}$ | [Fig. I (a).] | " |
| 37. | $mx'_{0} + m_{1}y_{0} \text{ ¶ } xy'_{1}$ | [Fig. III.] | " |
| 38. | $xm_{0} + my'_{0}$ | Fallacy of Like Eliminands not asserted to exist. | |
| 39. | $mx_{0} + my'_{1} \text{ ¶ } x'y'_{1}$ | [Fig. II.] | Concl. right. |
| 40. | $mx'_{0} + ym_{1} \text{ ¶ } xy_{1}$ | [Fig. II.] | " |

Solutions for § 7.

1. No doctors are enthusiastic;
You are enthusiastic.
You are not a doctor.

Univ. "persons"; m = enthusiastic; x = doctors; y = you.

$$xm_{\{0\}} + y_{\{1\}}m'_{\{0\}} \nparallel y_{\{1\}}x_{\{0\}} \text{ [Fig. I (a).]}$$

Conclusion right.

2. Dictionaries are useful;
Useful books are valuable.
Dictionaries are valuable.

Univ. "books"; m = useful; x = dictionaries; y = valuable.

$$x_{\{1\}}m'_{\{0\}} + m_{\{1\}}y'_{\{0\}} \nparallel x_{\{1\}}y'_{\{0\}} \text{ [Fig. I (a).]}$$

Conclusion right.

3. No misers are unselfish;
None but misers save egg-shells.
No unselfish people save egg-shells.

Univ. "people"; m = misers; x = selfish; y = people who save egg-shells.

$$mx'_{\{0\}} + m'y_{\{0\}} \nparallel x'y_{\{0\}} \text{ [Fig. I.]}$$

Conclusion right.

4. Some epicures are ungenerous;
All my uncles are generous.
My uncles are not epicures.

Univ. "persons"; m = generous; x = epicures; y = my uncles.

$$xm'_{\{1\}} + y_{\{1\}}m'_{\{0\}} \nparallel xy'_{\{1\}} \text{ [Fig. II.]}$$

Conclusion wrong: right one is "Some epicures are not uncles of mine."

5. Gold is heavy;
Nothing but gold will silence him.
Nothing light will silence him.

Univ. "things"; m = gold; x = heavy; y = able to silence him.

$$m_{\{1\}}x'_{\{0\}} + m'y_{\{0\}} \nparallel x'y_{\{0\}} \text{ [Fig. I.]}$$

Conclusion right.

6. Some healthy people are fat;
No unhealthy people are strong.
Some fat people are not strong.

Univ. "people"; m = healthy; x = fat; y = strong.

$$mx_{\{1\}} + m'y_{\{0\}}$$

No Conclusion. [Fallacy of Unlike Eliminands with an Entity-Premiss.]

7. I saw it in a newspaper;
All newspapers tell lies.
It was a lie.

Univ. "publications"; m = newspapers; x = publications in which I saw it; y = telling lies.

Symbolic Logic

$x_{\{1\}m'_{\{0\}} + m_{\{1\}y'_{\{0\}} \nrightarrow x_{\{1\}y'_{\{0\}}$ [Fig. I (a).

Conclusion wrong: right one is "The publication, in which I saw it, tells lies."

pg151

8. Some cravats are not artistic;
I admire anything artistic.
There are some cravats that I do not admire.

Univ. "things"; m = artistic; x = cravats; y = things that I admire.

$xm_{\{1\}} + m_{\{1\}y_{\{0\}}$

No Conclusion. [Fallacy of Unlike Eliminands with an Entity-Premiss.]

9. His songs never last an hour.
A song, that lasts an hour, is tedious.
His songs are never tedious.

Univ. "songs"; m = lasting an hour; x = his; y = tedious.

$x_{\{1\}m_{\{0\}} + m_{\{1\}y'_{\{0\}} \nrightarrow x'y_{\{1\}}$ [Fig. III.

Conclusion wrong: right one is "Some tedious songs are not his."

10. Some candles give very little light;
Candles are meant to give light.
Some things, that are meant to give light, give very little.

Univ. "things"; m = candles; x = giving &c.; y = meant &c.

$mx_{\{1\}} + m_{\{1\}y'_{\{0\}} \nrightarrow xy_{\{1\}}$ [Fig. II.

Conclusion right.

11. All, who are anxious to learn, work hard.
Some of these boys work hard.
Some of these boys are anxious to learn.

Univ. "persons"; m = hard-working; x = anxious to learn; y = these boys.

$x_{\{1\}m'_{\{0\}} + ym_{\{1\}}$

No Conclusion. [Fallacy of Unlike Eliminands with an Entity-Premiss.]

12. All lions are fierce;
Some lions do not drink coffee.
Some creatures that drink coffee are not fierce.

Univ. "creatures"; m = lions; x = fierce; y = creatures that drink coffee.

$m_{\{1\}x'_{\{0\}} + my'_{\{1\}} \nrightarrow xy'_{\{1\}}$ [Fig. II.

Conclusion wrong: right one is "Some fierce creatures do not drink coffee."

13. No misers are generous;
Some old men are ungenerous.
Some old men are misers.

Univ. "persons"; m = generous; x = misers; y = old men.

$xm_{\{0\}} + ym'_{\{1\}}$

No Conclusion. [Fallacy of Unlike Eliminands with an Entity-Premiss.]

Symbolic Logic

14. No fossil can be crossed in love;
 An oyster may be crossed in love.
 Oysters are not fossils.

Univ. "things"; m = things that can be crossed in love; x = fossils;
 y = oysters.

$$x_{m_{0}} + y_{1}m'_{0} \nrightarrow y_{1}x_{0} \text{ [Fig. I (a).]}$$

Conclusion right.

pg152

15. All uneducated people are shallow;
 Students are all educated.
 No students are shallow.

Univ. "people"; m = educated; x = shallow; y = students.

$$m'_{1}x'_{0} + y_{1}m'_{0} \nrightarrow xy'_{1} \text{ [Fig. III.]}$$

Conclusion wrong: right one is "Some shallow people are not students."

16. All young lambs jump;
 No young animals are healthy, unless they jump.
 All young lambs are healthy.

Univ. "young animals"; m = young animals that jump; x = lambs;
 y = healthy.

$$x_{1}m'_{0} + m'y_{0}$$

No Conclusion. [Fallacy of Like Eliminands not asserted to exist.]

17. Ill-managed business is unprofitable;
 Railways are never ill-managed.
 All railways are profitable.

Univ. "business"; m = ill-managed; x = profitable; y = railways.

$$m_{1}x_{0} + y_{1}m_{0} \nrightarrow x'y'_{1} \text{ [Fig. III.]}$$

Conclusion wrong: right one is "Some business, other than railways, is profitable."

18. No Professors are ignorant;
 All ignorant people are vain.
 No Professors are vain.

Univ. "people"; m = ignorant; x = Professors; y = vain.

$$x_{m_{0}} + m_{1}y'_{0} \nrightarrow x'y_{1} \text{ [Fig. III.]}$$

Conclusion wrong: right one is "Some vain persons are not Professors."

19. A prudent man shuns hyænas.
 No banker is imprudent.
 No banker fails to shun hyænas.

Univ. "men"; m = prudent; x = shunning hyænas; y = bankers.

$$m_{1}x'_{0} + ym'_{0} \nrightarrow x'y_{0} \text{ [Fig. I.]}$$

Conclusion right.

20. All wasps are unfriendly;
 No puppies are unfriendly.
 No puppies are wasps.

Univ. "creatures"; m = friendly; x = wasps; y = puppies.

Symbolic Logic

$x_{\{1\}m_{\{0\}} + ym'_{\{0\}} \nrightarrow x_{\{1\}y_{\{0\}}$ [Fig. I (a)].

Conclusion incomplete: complete one is "wasps are not puppies".

- 21. No Jews are honest;
Some Gentiles are rich.
Some rich people are dishonest.

Univ. "persons"; m = Jews; x = honest; y = rich.

$mx_{\{0\}} + m'y_{\{1\}}$

No Conclusion. [Fallacy of Unlike Eliminands with an Entity-Premiss.] pg153

- 22. No idlers win fame;
Some painters are not idle.
Some painters win fame.

Univ. "persons"; m = idlers; x = persons who win fame; y = painters.

$mx_{\{0\}} + ym'_{\{1\}}$

No Conclusion. [Fallacy of Unlike Eliminands with an Entity-Premiss.]

- 23. No monkeys are soldiers;
All monkeys are mischievous.
Some mischievous creatures are not soldiers.

Univ. "creatures"; m = monkeys; x = soldiers; y = mischievous.

$mx_{\{0\}} + m_{\{1\}y'_{\{0\}} \nrightarrow x'y_{\{1\}}$ [Fig. III.]

Conclusion right.

- 24. All these bonbons are chocolate-creams;
All these bonbons are delicious.
Chocolate-creams are delicious.

Univ. "food"; m = these bonbons; x = chocolate-creams; y = delicious.

$m_{\{1\}x'_{\{0\}} + m_{\{1\}y'_{\{0\}} \nrightarrow xy_{\{1\}}$ [Fig. III.]

Conclusion wrong, being in excess of the right one, which is "Some chocolate-creams are delicious."

- 25. No muffins are wholesome;
All buns are unwholesome.
Buns are not muffins.

Univ. "food"; m = wholesome; x = muffins; y = buns.

$xm_{\{0\}} + y_{\{1\}m_{\{0\}}$

No Conclusion. [Fallacy of Like Eliminands not asserted to exist.]

- 26. Some unauthorised reports are false;
All authorised reports are trustworthy.
Some false reports are not trustworthy.

Univ. "reports"; m = authorised; x = true; y = trustworthy.

$m'x'_{\{1\}} + m_{\{1\}y'_{\{0\}}$

No Conclusion. [Fallacy of Unlike Eliminands with an Entity-Premiss.]

- 27. Some pillows are soft;
No pokers are soft.

Symbolic Logic

Some pokers are not pillows.

Univ. "things"; m = soft; x = pillows; y = pokers.

$xm_{\{1\}} + ym_{\{0\}} \nVdash xy'_{\{1\}}$ [Fig. II.]

Conclusion wrong: right one is "Some pillows are not pokers."

28. Improbable stories are not easily believed;
None of his stories are probable.
None of his stories are easily believed.

Univ. "stories"; m = probable; x = easily believed; y = his.

$m'_{\{1\}}x_{\{0\}} + ym_{\{0\}} \nVdash xy_{\{0\}}$ [Fig. I.]

Conclusion right.

pg154

29. No thieves are honest;
Some dishonest people are found out.
Some thieves are found out.

Univ. "people"; m = honest; x = thieves; y = found out.

$xm_{\{0\}} + m'y_{\{1\}}$

No Conclusion. [Fallacy of Unlike Eliminands with an Entity-Premiss.]

30. No muffins are wholesome;
All puffy food is unwholesome.
All muffins are puffy.

Univ. is "food"; m = wholesome; x = muffins; y = puffy.

$xm_{\{0\}} + y_{\{1\}}m_{\{0\}}$

No Conclusion. [Fallacy of Like Eliminands not asserted to exist.]

31. No birds, except peacocks, are proud of their tails;
Some birds, that are proud of their tails, cannot sing.
Some peacocks cannot sing.

Univ. "birds"; m = proud of their tails; x = peacocks; y = birds that cannot sing.

$x'm_{\{0\}} + my'_{\{1\}} \nVdash xy'_{\{1\}}$ [Fig. II.]

Conclusion right.

32. Warmth relieves pain;
Nothing, that does not relieve pain, is useful in toothache.
Warmth is useful in toothache.

Univ. "applications"; m = relieving pain; x = warmth; y = useful in toothache.

$x_{\{1\}}m'_{\{0\}} + m'y_{\{0\}}$

No Conclusion. [Fallacy of Like Eliminands not asserted to exist.]

33. No bankrupts are rich;
Some merchants are not bankrupts.
Some merchants are rich.

Univ. "persons"; m = bankrupts; x = rich; y = merchants.

$mx_{\{0\}} + ym'_{\{1\}}$

Symbolic Logic

No Conclusion. [Fallacy of Unlike Eliminands with an Entity-Premiss.]

- 34. Bores are dreaded;
No bore is ever begged to prolong his visit.
No one, who is dreaded, is ever begged to prolong his visit.

Univ. "persons"; m = bores; x = dreaded; y = begged to prolong their visits.

$$m_{1}x'_{0} + my_{0} \nrightarrow xy'_{1} \text{ [Fig. III.]}$$

Conclusion wrong: the right one is "Some dreaded persons are not begged to prolong their visits."

- 35. All wise men walk on their feet;
All unwise men walk on their hands.
No man walks on both.

Univ. "men"; m = wise; x = walking on their feet; y = walking on their hands.

$$m_{1}x'_{0} + m'_{1}y'_{0} \nrightarrow x'y'_{0} \text{ [Fig. I.]}$$

Conclusion wrong: right one is "No man walks on neither."

pg155

- 36. No wheelbarrows are comfortable;
No uncomfortable vehicles are popular.
No wheelbarrows are popular.

Univ. "vehicles"; m = comfortable; x = wheelbarrows; y = popular.

$$xm_{0} + m'x_{0} \nrightarrow xy_{0} \text{ [Fig. I.]}$$

Conclusion right.

- 37. No frogs are poetical;
Some ducks are unpoetical.
Some ducks are not frogs.

Univ. "creatures"; m = poetical; x = frogs; y = ducks.

$$xm_{0} + ym'_{1}$$

No Conclusion. [Fallacy of Unlike Eliminands with an Entity-Premiss.]

- 38. No emperors are dentists;
All dentists are dreaded by children.
No emperors are dreaded by children.

Univ. "persons"; m = dentists; x = emperors; y = dreaded by children.

$$xm_{0} + m_{1}y'_{0} \nrightarrow x'y_{1} \text{ [Fig. III.]}$$

Conclusion wrong: right one is "Some persons, dreaded by children, are not emperors."

- 39. Sugar is sweet;
Salt is not sweet.
Salt is not sugar.

Univ. "things"; m = sweet; x = sugar; y = salt.

$$x_{1}m'_{0} + y_{1}m_{0} \nrightarrow (x_{1}y_{0} + y_{1}x_{0}) \text{ [Fig. I (b).]}$$

Conclusion incomplete: omitted portion is "Sugar is not salt."

- 40. Every eagle can fly;
Some pigs cannot fly.

Symbolic Logic

Some pigs are not eagles.

Univ. "creatures"; m = creatures that can fly; x = eagles; y = pigs.

$$x_{\{1\}m'_{\{0\}} + ym'_{\{1\}} \vee x'y_{\{1\}} \text{ [Fig. II.]}$$

Conclusion right.

Solutions for § 8.

SL8

$$1. \quad \overset{1}{cd}_{\{0\}} + \overset{2}{a}_{\{1\}}\overset{3}{d'}_{\{0\}} + \overset{3}{b}_{\{1\}}\overset{3}{c'}_{\{0\}};$$

$$\overset{1}{cd} + \overset{2}{ad'} + \overset{3}{bc'} \vee \overset{3}{ab}_{\{0\}} + \overset{1}{a}_{\{1\}} + \overset{1}{b}_{\{1\}}$$

$$\text{i.e. } \vee \overset{1}{a}_{\{1\}}\overset{3}{b}_{\{0\}} + \overset{1}{b}_{\{1\}}\overset{3}{a}_{\{0\}}$$

$$2. \quad \overset{1}{d}_{\{1\}}\overset{3}{b'}_{\{0\}} + \overset{2}{ac'}_{\{0\}} + \overset{3}{bc}_{\{0\}};$$

$$\overset{1}{db'} + \overset{3}{bc} + \overset{2}{ac'} \vee \overset{3}{da}_{\{0\}} + \overset{1}{d}_{\{1\}} \text{ i.e. } \vee \overset{1}{d}_{\{1\}}\overset{3}{a}_{\{0\}}$$

$$3. \quad \overset{1}{ba}_{\{0\}} + \overset{2}{cd'}_{\{0\}} + \overset{3}{d}_{\{1\}}\overset{3}{b'}_{\{0\}};$$

$$\overset{1}{ba} + \overset{3}{db'} + \overset{2}{cd'} \vee \overset{3}{ac}_{\{0\}}$$

$$4. \quad \overset{1}{bc}_{\{0\}} + \overset{2}{a}_{\{1\}}\overset{3}{b'}_{\{0\}} + \overset{3}{c'd}_{\{0\}};$$

$$\overset{1}{bc} + \overset{2}{ab'} + \overset{3}{c'd} \vee \overset{3}{ad}_{\{0\}} + \overset{1}{a}_{\{1\}} \text{ i.e. } \vee \overset{1}{a}_{\{1\}}\overset{3}{d}_{\{0\}}$$

$$5. \quad \overset{1}{b'_{\{1\}}a}_{\{0\}} + \overset{2}{bc}_{\{0\}} + \overset{3}{a'd}_{\{0\}}; \quad \overset{1}{b'a} + \overset{2}{bc} + \overset{3}{a'd} \vee \overset{3}{cd}_{\{0\}}$$

pg156

$$6. \quad \overset{1}{a}_{\{1\}}\overset{3}{b}_{\{0\}} + \overset{2}{b'c}_{\{0\}} + \overset{3}{d}_{\{1\}}\overset{3}{a'}_{\{0\}};$$

$$\overset{1}{ab} + \overset{2}{b'c} + \overset{3}{da'} \vee \overset{3}{cd}_{\{0\}} + \overset{1}{d}_{\{1\}} \text{ i.e. } \vee \overset{1}{d}_{\{1\}}\overset{3}{c}_{\{0\}}$$

$$7. \quad \overset{1}{db'}_{\{0\}} + \overset{2}{b}_{\{1\}}\overset{3}{a'}_{\{0\}} + \overset{3}{cd'}_{\{0\}}; \quad \overset{1}{db'} + \overset{2}{ba'} + \overset{3}{cd'} \vee \overset{3}{a'c}_{\{0\}}$$

$$8. \quad \overset{1}{b'd}_{\{0\}} + \overset{2}{a'b}_{\{0\}} + \overset{3}{c}_{\{1\}}\overset{3}{d'}_{\{0\}};$$

$$\overset{1}{b'd} + \overset{2}{a'b} + \overset{3}{cd'} \vee \overset{3}{a'c}_{\{0\}} + \overset{1}{c}_{\{1\}} \text{ i.e. } \vee \overset{1}{c}_{\{1\}}\overset{3}{a'}_{\{0\}}$$

$$9. \quad \overset{1}{b'_{\{1\}}a'}_{\{0\}} + \overset{2}{ad}_{\{0\}} + \overset{3}{b}_{\{1\}}\overset{3}{c'}_{\{0\}};$$

$$\overset{1}{b'a'} + \overset{2}{ad} + \overset{3}{bc'} \vee \overset{3}{dc}_{\{0\}}$$

Symbolic Logic

-- = =

$$10. \overset{1}{cd}_{\{0\}} + \overset{2}{b_{\{1\}}c'_{\{0\}}} + \overset{3}{ad'_{\{0\}}};$$

$$\overset{1}{cd} + \overset{2}{bc'} + \overset{3}{ad'} \quad \vee \quad \overset{1}{ba}_{\{0\}} + \overset{2}{b_{\{1\}}} \quad \text{i.e.} \quad \vee \quad \overset{1}{b_{\{1\}}}a_{\{0\}}$$

$$11. \overset{1}{bc}_{\{0\}} + \overset{2}{d_{\{1\}}a'_{\{0\}}} + \overset{3}{c'_{\{1\}}a_{\{0\}}};$$

$$\overset{1}{bc} + \overset{3}{c'a} + \overset{2}{da'} \quad \vee \quad \overset{1}{bd}_{\{0\}} + \overset{2}{d_{\{1\}}} \quad \text{i.e.} \quad \vee \quad \overset{1}{d_{\{1\}}}b_{\{0\}}$$

$$12. \overset{1}{cb'_{\{0\}}} + \overset{2}{c'_{\{1\}}d_{\{0\}}} + \overset{3}{b_{\{1\}}a'_{\{0\}}};$$

$$\overset{1}{cb'} + \overset{2}{c'd} + \overset{3}{ba'} \quad \vee \quad \overset{1}{da'_{\{0\}}}$$

$$13. \overset{1}{d_{\{1\}}e'_{\{0\}}} + \overset{2}{c_{\{1\}}a'_{\{0\}}} + \overset{3}{bd'_{\{0\}}} + \overset{4}{e_{\{1\}}a_{\{0\}}};$$

$$\overset{1}{de'} + \overset{3}{bd'} + \overset{4}{ea} + \overset{2}{ca'} \quad \vee \quad \overset{1}{bc}_{\{0\}} + \overset{2}{c_{\{1\}}} \quad \text{i.e.} \quad \vee \quad \overset{1}{c_{\{1\}}}b_{\{0\}}$$

$$14. \overset{1}{c_{\{1\}}b'_{\{0\}}} + \overset{2}{a_{\{1\}}e'_{\{0\}}} + \overset{3}{d_{\{1\}}b_{\{0\}}} + \overset{4}{a'_{\{1\}}c'_{\{0\}}};$$

$$\overset{1}{cb'} + \overset{3}{db} + \overset{4}{a'c'} + \overset{2}{ae'} \quad \vee \quad \overset{1}{de'_{\{0\}}} + \overset{2}{d_{\{1\}}} \quad \text{i.e.} \quad \vee \quad \overset{1}{d_{\{1\}}}e'_{\{0\}}$$

$$15. \overset{1}{b'd_{\{0\}}} + \overset{2}{e_{\{1\}}c'_{\{0\}}} + \overset{3}{b_{\{1\}}a'_{\{0\}}} + \overset{4}{d'_{\{1\}}c_{\{0\}}};$$

$$\overset{1}{b'd} + \overset{3}{ba'} + \overset{4}{d'c} + \overset{2}{ec'} \quad \vee \quad \overset{1}{a'e}_{\{0\}} + \overset{2}{e_{\{1\}}} \quad \text{i.e.} \quad \vee \quad \overset{1}{e_{\{1\}}}a'_{\{0\}}$$

$$16. \overset{1}{a'e_{\{0\}}} + \overset{2}{d_{\{1\}}c_{\{0\}}} + \overset{3}{a_{\{1\}}b'_{\{0\}}} + \overset{4}{e'_{\{1\}}d'_{\{0\}}};$$

$$\overset{1}{a'e} + \overset{3}{ab'} + \overset{4}{e'd'} + \overset{2}{dc} \quad \vee \quad \overset{1}{b'c}_{\{0\}}$$

$$17. \overset{1}{d_{\{1\}}c'_{\{0\}}} + \overset{2}{a_{\{1\}}e'_{\{0\}}} + \overset{3}{bd'_{\{0\}}} + \overset{4}{c_{\{1\}}e_{\{0\}}};$$

$$\overset{1}{dc'} + \overset{3}{bd'} + \overset{4}{ce} + \overset{2}{ae'} \quad \vee \quad \overset{1}{ba}_{\{0\}} + \overset{2}{a_{\{1\}}} \quad \text{i.e.} \quad \vee \quad \overset{1}{a_{\{1\}}}b_{\{0\}}$$

$$18. \overset{1}{a_{\{1\}}b'_{\{0\}}} + \overset{2}{d_{\{1\}}e'_{\{0\}}} + \overset{3}{a'_{\{1\}}c_{\{0\}}} + \overset{4}{be_{\{0\}}};$$

$$\overset{1}{ab'} + \overset{3}{a'c} + \overset{4}{be} + \overset{2}{de'} \quad \vee \quad \overset{1}{cd}_{\{0\}} + \overset{2}{d_{\{1\}}} \quad \text{i.e.} \quad \vee \quad \overset{1}{d_{\{1\}}}c_{\{0\}}$$

$$19. \overset{1}{bc}_{\{0\}} + \overset{2}{e_{\{1\}}h'_{\{0\}}} + \overset{3}{a_{\{1\}}b'_{\{0\}}} + \overset{4}{dh_{\{0\}}} + \overset{5}{e'_{\{1\}}c'_{\{0\}}};$$

Symbolic Logic

$$\frac{bc}{--} + \frac{ab'}{=} + \frac{e'c'}{-} + \frac{eh'}{==} + \frac{dh}{=} \quad \text{¶} \quad ad_{\{0\}} + a_{\{1\}}$$

i.e. ¶ $a_{\{1\}}d_{\{0\}}$

20. $dh'_{\{0\}} + ce_{\{0\}} + h_{\{1\}}b'_{\{0\}} + ad'_{\{0\}} + be'_{\{0\}};$

$$\frac{dh'}{--} + \frac{hb'}{==} + \frac{ad'}{=} + \frac{be'}{==} + \frac{ce}{=} \quad \text{¶} \quad ac_{\{0\}}$$

21. $b_{\{1\}}a'_{\{0\}} + dh_{\{0\}} + ce_{\{0\}} + ah'_{\{0\}} + c'_{\{1\}}b'_{\{0\}};$

$$\frac{ba'}{--} + \frac{ah'}{==} + \frac{dh}{=} + \frac{c'b'}{-} + \frac{ce}{=} \quad \text{¶} \quad de_{\{0\}}$$

22. $e_{\{1\}}d_{\{0\}} + b'h'_{\{0\}} + c'_{\{1\}}d'_{\{0\}} + a_{\{1\}}e'_{\{0\}} + ch_{\{0\}};$

$$\frac{ed}{--} + \frac{c'd'}{-} + \frac{ae'}{=} + \frac{ch}{==} + \frac{b'h'}{=} \quad \text{¶} \quad ab'_{\{0\}} + a_{\{1\}}$$

i.e. ¶ $a_{\{1\}}b_{\{0\}}$

pg157

23. $b'_{\{1\}}a_{\{0\}} + de'_{\{0\}} + h_{\{1\}}b_{\{0\}} + ce_{\{0\}} + d'_{\{1\}}a'_{\{0\}};$

$$\frac{b'a}{-} + \frac{hb}{=} + \frac{d'a'}{-} + \frac{de'}{==} + \frac{ce}{=}$$

¶ $hc_{\{0\}} + h_{\{1\}}$ i.e. ¶ $h_{\{1\}}c_{\{0\}}$

24. $h'_{\{1\}}k_{\{0\}} + b'a_{\{0\}} + c_{\{1\}}d'_{\{0\}} + e_{\{1\}}h_{\{0\}} + dk'_{\{0\}} + bc'_{\{0\}};$

$$\frac{h'k}{-} + \frac{eh}{=} + \frac{dk'}{-} + \frac{cd'}{-} + \frac{bc'}{-} + \frac{b'a}{=} \quad \text{¶} \quad ea_{\{0\}} + e_{\{1\}}$$

i.e. ¶ $e_{\{1\}}a_{\{0\}}$

25. $a_{\{1\}}d'_{\{0\}} + k_{\{1\}}b'_{\{0\}} + e_{\{1\}}h'_{\{0\}} + a'b_{\{0\}}$

$$+ d_{\{1\}}c'_{\{0\}} + h_{\{1\}}k'_{\{0\}};$$

$$\frac{ad'}{--} + \frac{a'b}{=} + \frac{kb'}{-} + \frac{dc'}{=} + \frac{hk'}{-} + \frac{eh'}{=} \quad \text{¶} \quad c'e_{\{0\}} + e_{\{1\}}$$

i.e. ¶ $e_{\{1\}}c'_{\{0\}}$

26. $a'_{\{1\}}h'_{\{0\}} + d'k'_{\{0\}} + e_{\{1\}}b_{\{0\}} + hk_{\{0\}} + a_{\{1\}}c'_{\{0\}}$

$$+ b'd_{\{0\}};$$

$$\frac{a'h'}{-} + \frac{hk}{==} + \frac{d'k'}{-} + \frac{ac'}{=} + \frac{b'd}{-} + \frac{eb}{=} \quad \text{¶} \quad c'e_{\{0\}} + e_{\{1\}}$$

Symbolic Logic

i.e. $\neg e_{1}c'_{0}$

$$27. e_{1}d_{0} + hb_{0} + a'_{1}k'_{0} + ce'_{0} + b'_{1}d'_{0} + ac'_{0};$$

$$\begin{array}{cccccc} 1 & 4 & 5 & 2 & 6 & 3 \\ ed & + & ce' & + & b'd' & + & hb & + & ac' & + & a'k' & \neg & hk'_{0} \\ \text{---} & & \text{--} & & \text{--} & & \text{=} & & \text{--} & & \text{=} & & \text{=} \end{array}$$

$$28. a'_{1}k'_{0} + e_{1}b'_{0} + hk'_{0} + d'_{4}c'_{0} + ab_{0} + c'_{1}h'_{0};$$

$$\begin{array}{cccccc} 1 & 3 & 5 & 2 & 6 & 4 \\ a'k & + & hk' & + & ab & + & eb' & + & c'h' & + & d'c & \neg & ed'_{0} & + & e_{1} \\ \text{--} & & \text{--} & & \text{--} & & \text{=} & & \text{--} & & \text{=} & & \text{=} & & \text{=} \end{array}$$

i.e. $\neg e_{1}d'_{0}$

$$29. ek_{0} + b'_{2}m_{0} + ac'_{3} + h'_{1}e'_{0} + d_{1}k'_{0} + cb_{6} + d'_{1}l'_{0} + hm'_{8};$$

$$\begin{array}{cccccc} 1 & 4 & 5 & 7 & 8 & 2 & 6 & 3 \\ ek & + & h'e' & + & dk' & + & d'l' & + & hm' & + & b'm & + & cb & + & ac' \\ \text{--} & & \text{--} & & \text{--} & & \text{=} & & \text{--} & & \text{--} & & \text{--} & & \text{=} \end{array}$$

 $\neg l'a_{0}$

$$30. n_{1}m'_{0} + a'_{1}e'_{0} + c'_{3}l'_{0} + k_{1}r_{0} + ah'_{5} + d'_{6}l'_{0} + cn'_{7} + e_{1}b'_{0} + m_{1}r'_{0} + h_{1}d'_{0};$$

$$\begin{array}{cccccc} 1 & 7 & 3 & 6 & 9 & 4 & 10 & 5 & 2 & 8 \\ nm' & + & cn' & + & c'l' & + & d'l' & + & mr' & + & kr & + & hd' & + & ah' & + & a'e' & + & eb' \\ \text{--} & & \text{--} & & \text{--} & & \text{--} & & \text{--} & & \text{--} & & \text{--} & & \text{--} & & \text{--} & & \text{--} \end{array}$$

 $\neg kb'_{0} + k_{1}$ i.e. $\neg k_{1}b'_{0}$

Solutions for § 9.

SL9

1.

$$b_{1}d_{0} + ac_{0} + d'_{1}c'_{0};$$

$$\begin{array}{ccc} 1 & 3 & 2 \\ bd & + & d'c' & + & ac & \neg & ba_{0} & + & b_{1} \\ \text{--} & & \text{--} & & \text{--} & & \text{--} & & \text{--} \end{array}$$

i.e. Babies cannot manage crocodiles.

2.

$$a_{1}b'_{0} + d_{1}c'_{0} + bc_{0};$$

$$\begin{array}{ccc} 1 & 3 & 2 \end{array}$$

Symbolic Logic

$$\overline{ab'} + \underline{bc} + \underline{dc'} \quad \vee \quad \overline{ad_{\{0\}} + d_{\{1\}}}, \text{ i.e. } \vee \overline{d_{\{1\}}a_{\{0\}}}$$

i.e. _Your_ presents to me are not made of tin.

pg158

3.

$$d_{\{0\}}^1 + c_{\{1\}}^2 b'_{\{0\}} + a' b_{\{0\}}^3;$$

$$\overline{d_{\{0\}}^1} + \overline{a' b_{\{0\}}^3} + \overline{c_{\{1\}}^2} \quad \vee \quad \overline{d_{\{0\}} + c_{\{1\}}}, \text{ i.e. } \vee \overline{c_{\{1\}}d_{\{0\}}}$$

i.e. All my potatoes in this dish are old ones.

4.

$$b_{\{0\}}^1 + b' d_{\{0\}}^2 + c_{\{1\}}^3 a'_{\{0\}};$$

$$\overline{b_{\{0\}}^1} + \overline{b' d_{\{0\}}^2} + \overline{c_{\{1\}}^3} \quad \vee \quad \overline{d_{\{0\}} + c_{\{1\}}}, \text{ i.e. } \vee \overline{c_{\{1\}}d_{\{0\}}}$$

i.e. My servants never say "shpoonj."

5.

$$a d_{\{0\}}^1 + c d'_{\{0\}}^2 + b_{\{1\}}^3 a'_{\{0\}};$$

$$\overline{a d_{\{0\}}^1} + \overline{c d'_{\{0\}}^2} + \overline{b_{\{1\}}^3} \quad \vee \quad \overline{c b_{\{0\}} + b_{\{1\}}}, \text{ i.e. } \vee \overline{b_{\{1\}}c_{\{0\}}}$$

i.e. My poultry are not officers.

6.

$$c_{\{1\}}^1 a'_{\{0\}} + c' b_{\{0\}}^2 + d a_{\{0\}}^3; \quad \overline{c a'_{\{0\}}} + \overline{c' b_{\{0\}}} + \overline{d a_{\{0\}}} \quad \vee \quad \overline{b d_{\{0\}}}$$

i.e. None of your sons are fit to serve on a jury.

7.

$$c b_{\{0\}}^1 + d a_{\{0\}}^2 + b'_{\{1\}} a'_{\{0\}}^3; \quad \overline{c b_{\{0\}}} + \overline{b'_{\{1\}} a'_{\{0\}}} + \overline{d a_{\{0\}}} \quad \vee \quad \overline{c d_{\{0\}}}$$

i.e. No pencils of mine are sugarplums.

8.

$$c b'_{\{0\}}^1 + d_{\{1\}}^2 a'_{\{0\}} + b a_{\{0\}}^3;$$

$$\overline{c b'_{\{0\}}^1} + \overline{b a_{\{0\}}^3} + \overline{d_{\{1\}}^2} \quad \vee \quad \overline{c d_{\{0\}} + d_{\{1\}}}, \text{ i.e. } \vee \overline{d_{\{1\}}c_{\{0\}}}$$

i.e. Jenkins is inexperienced.

9.

Symbolic Logic

$$cd_{\{0\}} + d'a_{\{0\}} + c'b_{\{0\}}; \quad \underline{\underline{cd}} + \underline{\underline{d'a}} + \underline{\underline{c'b}} \quad \nabla \quad \underline{\underline{ab}}_{\{0\}}$$

i.e. No comet has a curly tail.

10.

$$d^1c_{\{0\}} + ba_{\{0\}} + a^3_{\{1\}}d_{\{0\}}; \quad \underline{\underline{d^1c}} + \underline{\underline{a^3d}} + \underline{\underline{ba}} \quad \nabla \quad \underline{\underline{cb}}_{\{0\}}$$

i.e. No hedgehog takes in the Times.

11.

$$b_{\{1\}}a^1_{\{0\}} + c_{\{1\}}b^2_{\{0\}} + ad_{\{0\}}^3;$$

$$\underline{\underline{ba^1}} + \underline{\underline{cb^2}} + \underline{\underline{ad^3}} \quad \nabla \quad \underline{\underline{cd}}_{\{0\}} + c_{\{1\}}, \quad \text{i.e.} \quad \nabla \quad \underline{\underline{c_{\{1\}}d}}_{\{0\}}$$

i.e. This dish is unwholesome.

12.

$$b_{\{1\}}c^1_{\{0\}} + d^2a_{\{0\}} + a^3c_{\{0\}};$$

$$\underline{\underline{bc^1}} + \underline{\underline{a^3c}} + \underline{\underline{d^2a}} \quad \nabla \quad \underline{\underline{bd^2}}_{\{0\}} + b_{\{1\}}, \quad \text{i.e.} \quad \nabla \quad \underline{\underline{b_{\{1\}}d^2}}_{\{0\}}$$

i.e. My gardener is very old.

13.

$$a_{\{1\}}d^1_{\{0\}} + bc_{\{0\}}^2 + c^3_{\{1\}}d_{\{0\}};$$

$$\underline{\underline{ad^1}} + \underline{\underline{c^3d}} + \underline{\underline{bc^2}} \quad \nabla \quad \underline{\underline{ab}}_{\{0\}} + a_{\{1\}}, \quad \text{i.e.} \quad \nabla \quad \underline{\underline{a_{\{1\}}b}}_{\{0\}}$$

i.e. All humming-birds are small.

pg159

14.

$$c^1b_{\{0\}} + a_{\{1\}}d^2_{\{0\}} + ca^3_{\{0\}}; \quad \underline{\underline{c^1b}} + \underline{\underline{ca^3}} + \underline{\underline{ad^2}} \quad \nabla \quad \underline{\underline{bd^2}}_{\{0\}}$$

i.e. No one with a hooked nose ever fails to make money.

15.

$$b_{\{1\}}a^1_{\{0\}} + b^2_{\{1\}}d_{\{0\}} + ca_{\{0\}}^3; \quad \underline{\underline{ba^1}} + \underline{\underline{b^2d}} + \underline{\underline{ca^3}} \quad \nabla \quad \underline{\underline{dc}}_{\{0\}}$$

i.e. No gray ducks in this village wear lace collars.

16.

$$d_{\{1\}}b^1_{\{0\}} + cd^2_{\{0\}} + ba_{\{0\}}^3; \quad \underline{\underline{db^1}} + \underline{\underline{cd^2}} + \underline{\underline{ba^3}} \quad \nabla \quad \underline{\underline{ca}}_{\{0\}}$$

Symbolic Logic

i.e. No jug in this cupboard will hold water.

17.

$$b'_{1}d_{0} + c_{1}d'_{0} + ab_{0};$$

$$\frac{1}{-}b'd + \frac{2}{=}cd' + \frac{3}{=}ab \quad \vee \quad ca_{0} + c_{1}, \text{ i.e. } \vee c_{1}a_{0}$$

i.e. These apples were grown in the sun.

18.

$$d'_{1}b'_{0} + c_{1}b_{0} + c'a_{0};$$

$$\frac{1}{-}d'b' + \frac{2}{=}cb + \frac{3}{=}c'a \quad \vee \quad d'a_{0} + d'_{1}, \text{ i.e. } \vee d'_{1}a_{0}$$

i.e. Puppies, that will not lie still, never care to do worsted-work.

19.

$$bd'_{0} + a_{1}c'_{0} + a'd_{0}; \quad \frac{1}{-}bd' + \frac{3}{-}a'd + \frac{2}{=}ac' \quad \vee \quad bc'_{0}$$

i.e. No name in this list is unmelodious.

20.

$$a_{1}b'_{0} + dc_{0} + a'_{1}d'_{0}; \quad \frac{1}{-}ab' + \frac{3}{=}a'd' + \frac{2}{=}dc \quad \vee \quad b'c_{0}$$

i.e. No M.P. should ride in a donkey-race, unless he has perfect self-command.

21.

$$bd_{0} + c'a_{0} + b'c_{0}; \quad \frac{1}{-}bd + \frac{3}{=}b'c + \frac{2}{=}c'a \quad \vee \quad da_{0}$$

i.e. No goods in this shop, that are still on sale, may be carried away.

22.

$$a'b_{0} + cd_{0} + d'a_{0}; \quad \frac{1}{-}a'b + \frac{3}{-}d'a + \frac{2}{=}cd \quad \vee \quad bc_{0}$$

i.e. No acrobatic feat, which involves turning a quadruple somersault, is ever attempted in a circus.

23.

$$dc'_{0} + a_{1}b'_{0} + bc_{0};$$

$$\frac{1}{-}dc' + \frac{3}{=}bc + \frac{2}{=}ab' \quad \vee \quad da_{0} + a_{1}, \text{ i.e. } \vee a_{1}d_{0}$$

i.e. Guinea-pigs never really appreciate Beethoven.

Symbolic Logic

$$d_{\{1\}}e_{\{0\}} + c'a_{\{0\}} + b_{\{1\}}e'_{\{0\}} + c_{\{1\}}d'_{\{0\}};$$

$$\underset{-}{\overset{1}{d}}e + \underset{=}{\overset{3}{b}}e' + \underset{-}{\overset{4}{c}}d' + \underset{=}{\overset{2}{c'}}a \quad \vee \quad ba_{\{0\}} + b_{\{1\}}, \text{ i.e. } \vee b_{\{1\}}a_{\{0\}}$$

i.e. An egg of the Great Auk is not to be had for a song.

31.

$$d'b_{\{0\}} + a_{\{1\}}c'_{\{0\}} + c_{\{1\}}e'_{\{0\}} + a'd_{\{0\}};$$

$$\underset{-}{\overset{1}{d'}}b + \underset{-}{\overset{4}{a'}}d + \underset{=}{\overset{2}{a}}c' + \underset{=}{\overset{3}{c}}e' \quad \vee \quad be'_{\{0\}}$$

i.e. No books sold here have gilt edges unless they are priced at 5s. and upwards.

32.

$$a'_{\{1\}}c'_{\{0\}} + d_{\{1\}}b_{\{0\}} + a_{\{1\}}e'_{\{0\}} + c_{\{1\}}b'_{\{0\}};$$

$$\underset{-}{\overset{1}{a'}}c' + \underset{=}{\overset{3}{a}}e' + \underset{=}{\overset{4}{c}}b' + \underset{=}{\overset{2}{d}}b \quad \vee \quad e'd_{\{0\}} + d_{\{1\}}, \text{ i.e. } \vee d_{\{1\}}e'_{\{0\}}$$

i.e. When you cut your finger, you will find Tincture of Calendula useful.

33.

$$d'b_{\{0\}} + a_{\{1\}}e'_{\{0\}} + ec_{\{0\}} + d_{\{1\}}a'_{\{0\}};$$

$$\underset{-}{\overset{1}{d'}}b + \underset{=}{\overset{4}{d}}a' + \underset{=}{\overset{2}{a}}e' + \underset{=}{\overset{3}{e}}c \quad \vee \quad bc_{\{0\}}$$

i.e. I have never come across a mermaid at sea.

pg161

34.

$$c'_{\{1\}}b_{\{0\}} + a_{\{1\}}e'_{\{0\}} + d_{\{1\}}b'_{\{0\}} + a'_{\{1\}}c_{\{0\}};$$

$$\underset{-}{\overset{1}{c'}}b + \underset{=}{\overset{3}{d}}b' + \underset{-}{\overset{4}{a'}}c + \underset{=}{\overset{2}{a}}e' \quad \vee \quad de'_{\{0\}} + d_{\{1\}}, \text{ i.e. } \vee d_{\{1\}}e'_{\{0\}}$$

i.e. All the romances in this library are well-written.

35.

$$e'd_{\{0\}} + c'a_{\{0\}} + eb_{\{0\}} + d'c_{\{0\}};$$

$$\underset{-}{\overset{1}{e'}}d + \underset{=}{\overset{3}{e}}b + \underset{=}{\overset{4}{d'}}c + \underset{=}{\overset{2}{c'}}a \quad \vee \quad ba_{\{0\}}$$

i.e. No bird in this aviary lives on mince-pies.

36.

Symbolic Logic

$$d'_{1}c'_{0} + e_{1}a'_{0} + c_{1}b_{0} + e'd_{0};$$

$$\begin{array}{cccc} \overset{1}{d}c' & + & \overset{3}{c}b & + & \overset{4}{e}d & + & \overset{2}{e}a' & \text{¶} & \text{ba}'_{0} \end{array}$$

i.e. No plum-pudding, that has not been boiled in a cloth, can be distinguished from soup.

37.

$$ce'_{0} + b'a'_{0} + h_{1}d'_{0} + ae_{0} + bd_{0};$$

$$\begin{array}{cccccc} \overset{1}{c}e' & + & \overset{4}{a}e & + & \overset{2}{b}a' & + & \overset{5}{b}d & + & \overset{3}{h}d' & \text{¶} & \text{ch}_{0} & + & h_{1} & , & \text{i.e.} & \text{¶} & h_{1}c'_{0} \end{array}$$

i.e. All your poems are uninteresting.

38.

$$b'_{1}a'_{0} + db_{0} + he'_{0} + ec_{0} + a_{1}h'_{0};$$

$$\begin{array}{cccccc} \overset{1}{b}a' & + & \overset{4}{d}b & + & \overset{5}{a}h' & + & \overset{3}{h}e' & + & \overset{4}{e}c & \text{¶} & \text{dc}_{0} \end{array}$$

i.e. None of my peaches have been grown in a hothouse.

39.

$$c_{1}d_{0} + h_{1}e'_{0} + c'_{1}a'_{0} + h'b_{0} + e_{1}d'_{0};$$

$$\begin{array}{cccccc} \overset{1}{c}d & + & \overset{3}{c}a' & + & \overset{5}{e}d' & + & \overset{2}{h}e' & + & \overset{4}{h}b & \text{¶} & \text{a}'b_{0} \end{array}$$

i.e. No pawnbroker is dishonest.

40.

$$bd'_{0} + c'h_{0} + e_{1}b'_{0} + da_{0} + e'c_{0};$$

$$\begin{array}{cccccc} \overset{1}{b}d' & + & \overset{3}{e}b' & + & \overset{4}{d}a & + & \overset{5}{e}c & + & \overset{2}{c}h & \text{¶} & \text{a}h_{0} \end{array}$$

i.e. No kitten with green eyes will play with a gorilla.

41.

$$c_{1}a'_{0} + h'b_{0} + ae_{0} + d_{1}c'_{0} + h_{1}e'_{0};$$

$$\begin{array}{cccccc} \overset{1}{c}a' & + & \overset{3}{a}e & + & \overset{4}{d}c' & + & \overset{5}{h}e' & + & \overset{2}{h}b & \text{¶} & \text{db}_{0} & + & d_{1} & , & \text{i.e.} & \text{¶} & d_{1}b_{0} \end{array}$$

i.e. All my friends in this College dine at the lower table.

42.

$$ca_{0} + h_{1}d'_{0} + c'_{1}e'_{0} + b'a'_{0} + d_{1}e_{0};$$

Symbolic Logic

$$\overset{1}{c}a + \overset{3}{c}'\overset{4}{e}' + \overset{4}{b}'\overset{5}{a}' + \overset{5}{d}e + \overset{2}{h}d' \vee \overset{2}{b}'h_{\{0\}} + h_{\{1\}},$$

i.e. $\vee h_{\{1\}}b'_{\{0\}}$

i.e. My writing-desk is full of live scorpions.

43.

$$\overset{1}{b}'_{\{1\}}\overset{2}{e}_{\{0\}} + \overset{2}{a}h_{\{0\}} + \overset{3}{d}c_{\{0\}} + \overset{4}{e}'_{\{1\}}\overset{5}{a}'_{\{0\}} + \overset{5}{b}c'_{\{0\}}$$

$$\overset{1}{b}'e + \overset{4}{e}'a + \overset{2}{a}h + \overset{5}{b}c' + \overset{3}{d}c \vee \overset{3}{h}d_{\{0\}}$$

i.e. No Mandarin ever reads Hogg's poems.

pg162

44.

$$\overset{1}{e}_{\{1\}}\overset{2}{b}'_{\{0\}} + \overset{2}{a}'d_{\{0\}} + \overset{3}{c}_{\{1\}}\overset{4}{h}'_{\{0\}} + \overset{4}{e}'a_{\{0\}} + \overset{5}{d}'h_{\{0\}};$$

$$\overset{1}{e}b' + \overset{4}{e}'a + \overset{2}{a}'d + \overset{5}{d}'h + \overset{3}{c}h' \vee \overset{3}{b}'c_{\{0\}} + c_{\{1\}},$$

i.e. $\vee c_{\{1\}}b'_{\{0\}}$

i.e. Shakespeare was clever.

45.

$$\overset{1}{e}'_{\{1\}}\overset{2}{c}'_{\{0\}} + \overset{2}{h}b'_{\{0\}} + \overset{3}{d}_{\{1\}}\overset{4}{a}_{\{0\}} + \overset{4}{e}_{\{1\}}\overset{5}{a}'_{\{0\}} + \overset{5}{c}_{\{1\}}\overset{6}{b}_{\{0\}};$$

$$\overset{1}{e}'c' + \overset{4}{e}a' + \overset{2}{d}a + \overset{5}{c}b + \overset{3}{h}b' \vee \overset{3}{d}h_{\{0\}} + d_{\{1\}}, \text{ i.e. } \vee \overset{3}{d}_{\{1\}}h_{\{0\}}$$

i.e. Rainbows are not worth writing odes to.

46.

$$\overset{1}{c}'_{\{1\}}\overset{2}{h}'_{\{0\}} + \overset{2}{e}_{\{1\}}\overset{3}{a}_{\{0\}} + \overset{3}{b}d_{\{0\}} + \overset{4}{a}'_{\{1\}}\overset{5}{h}_{\{0\}} + \overset{5}{d}'c_{\{0\}};$$

$$\overset{1}{c}'h' + \overset{4}{a}'h + \overset{2}{e}a + \overset{5}{d}'c + \overset{3}{b}d \vee \overset{3}{e}b_{\{0\}} + e_{\{1\}}, \text{ i.e. } \vee \overset{3}{e}_{\{1\}}b_{\{0\}}$$

i.e. These Sorites-examples are difficult.

47.

$$\overset{1}{a}'_{\{1\}}\overset{2}{e}'_{\{0\}} + \overset{2}{b}k_{\{0\}} + \overset{3}{c}'a_{\{0\}} + \overset{4}{e}h'_{\{0\}} + \overset{5}{d}_{\{1\}}\overset{6}{b}'_{\{0\}} + \overset{6}{k}'h_{\{0\}};$$

$$\overset{1}{a}'e' + \overset{3}{c}'a + \overset{4}{e}h' + \overset{6}{k}'h + \overset{2}{b}k + \overset{5}{d}b' \vee \overset{5}{c}'d_{\{0\}} + d_{\{1\}},$$

i.e. $\vee \overset{5}{d}_{\{1\}}c'_{\{0\}}$

i.e. All my dreams come true.

Symbolic Logic

$$da'_{\{0\}} + k_{\{1\}}b'_{\{0\}} + c_{\{1\}}h_{\{0\}} + d'_{\{1\}}k'_{\{0\}} + e_{\{1\}}c'_{\{0\}} \\ + a_{\{1\}}h'_{\{0\}};$$

$$\begin{array}{cccccc} \overset{1}{da'} & + & \overset{4}{d'k'} & + & \overset{2}{kb'} & + & \overset{6}{ah'} & + & \overset{3}{ch} & + & \overset{5}{ec'} \\ \text{--} & & \text{--} & & \text{--} & & \text{--} & & \text{--} & & \text{--} \end{array}$$

$$\forall b'e_{\{0\}} + e_{\{1\}}, \text{ i.e. } \forall e_{\{1\}}b'_{\{0\}}$$

i.e. Rainy days are always cloudy.

54.

$$kb'_{\{0\}} + a'_{\{1\}}c'_{\{0\}} + d'_{\{1\}}b_{\{0\}} + k'_{\{1\}}h'_{\{0\}} + ea_{\{0\}} + d_{\{1\}}c_{\{0\}};$$

$$\begin{array}{cccccc} \overset{1}{kb'} & + & \overset{3}{d'b} & + & \overset{4}{k'h'} & + & \overset{6}{dc} & + & \overset{2}{a'c'} & + & \overset{5}{ea} \\ \text{--} & & \text{--} & & \text{--} & & \text{--} & & \text{--} & & \text{--} \end{array}$$

$$\forall h'e_{\{0\}}$$

i.e. No heavy fish is unkind to children.

55.

$$k'_{\{1\}}b'_{\{0\}} + eh'_{\{0\}} + c'_{\{1\}}d_{\{0\}} + hb_{\{0\}} + ac_{\{0\}} + kd'_{\{0\}};$$

$$\begin{array}{cccccc} \overset{1}{k'b'} & + & \overset{4}{hb} & + & \overset{2}{eh'} & + & \overset{6}{kd'} & + & \overset{3}{c'd} & + & \overset{5}{ac} \\ \text{--} & & \text{--} & & \text{--} & & \text{--} & & \text{--} & & \text{--} \end{array} \forall ea_{\{0\}}$$

i.e. No engine-driver lives on barley-sugar.

56.

$$h_{\{1\}}b'_{\{0\}} + c_{\{1\}}d'_{\{0\}} + k'a_{\{0\}} + e_{\{1\}}h'_{\{0\}} + b_{\{1\}}a'_{\{0\}} \\ + k_{\{1\}}c'_{\{0\}};$$

$$\begin{array}{cccccc} \overset{1}{hb'} & + & \overset{4}{eh'} & + & \overset{5}{ba'} & + & \overset{3}{k'a} & + & \overset{6}{kc'} & + & \overset{2}{cd'} \\ \text{--} & & \text{--} & & \text{--} & & \text{--} & & \text{--} & & \text{--} \end{array}$$

$$\forall ed'_{\{0\}} + e_{\{1\}}, \text{ i.e. } \forall e_{\{1\}}d'_{\{0\}}$$

i.e. All the animals in the yard gnaw bones.

57.

$$h'_{\{1\}}d'_{\{0\}} + e_{\{1\}}c'_{\{0\}} + k'a_{\{0\}} + cb_{\{0\}} + d_{\{1\}}l'_{\{0\}} + e'h_{\{0\}} \\ + kl_{\{0\}};$$

$$\begin{array}{cccccc} \overset{1}{h'd'} & + & \overset{5}{d'l'} & + & \overset{7}{kl} & + & \overset{3}{k'a} & + & \overset{6}{e'h} & + & \overset{2}{ec'} & + & \overset{4}{cb} \\ \text{--} & & \text{--} & & \text{--} & & \text{--} & & \text{--} & & \text{--} & & \text{--} \end{array} \forall ab_{\{0\}}$$

i.e. No badger can guess a conundrum.

58.

Symbolic Logic

$$\begin{array}{cccccc}
 1 & & 2 & & 3 & & 4 & & 5 & & 6 \\
 b'h_{\{0\}} & + & d'_{\{1\}}l'_{\{0\}} & + & ca_{\{0\}} & + & d_{\{1\}}k'_{\{0\}} & + & h'_{\{1\}}e'_{\{0\}} & + & mc'_{\{0\}} \\
 & & 7 & & 8 \\
 & + & a'b_{\{0\}} & + & ek_{\{0\}};
 \end{array}$$

$$\begin{array}{cccccccc}
 1 & & 5 & & 7 & & 3 & & 6 & & 8 & & 4 & & 2 \\
 b'h & + & h'e' & + & a'b & + & ca & + & mc' & + & ek & + & dk' & + & d'l' \quad \text{¶} \quad ml'_{\{0\}} \\
 - & - & = & - & - & = & - & = & = & - & = & - & - & = & =
 \end{array}$$

i.e. No cheque of yours, received by me, is payable to order.

59.

$$\begin{array}{cccccc}
 1 & & 2 & & 3 & & 4 & & 5 & & 6 \\
 c_{\{1\}}l'_{\{0\}} & + & h'e_{\{0\}} & + & kd_{\{0\}} & + & mc'_{\{0\}} & + & b'_{\{1\}}e'_{\{0\}} & + & n_{\{1\}}a'_{\{0\}} \\
 & & 7 & & 8 & & 9 \\
 & + & l_{\{1\}}d'_{\{0\}} & + & m'b_{\{0\}} & + & ah_{\{0\}};
 \end{array}$$

$$\begin{array}{cccccccc}
 1 & & 4 & & 7 & & 3 & & 8 & & 5 & & 2 & & 9 & & 6 \\
 cl' & + & mc' & + & ld' & + & kd & + & m'b & + & b'e' & + & h'e & + & ah & + & na' \\
 - & - & = & - & = & - & = & - & = & - & = & - & = & - & = & =
 \end{array}$$

¶ kn_{0}

i.e. I cannot read any of Brown's letters.

60.

$$\begin{array}{cccccc}
 1 & & 2 & & 3 & & 4 & & 5 & & 6 \\
 e_{\{1\}}c'_{\{0\}} & + & l_{\{1\}}n'_{\{0\}} & + & d_{\{1\}}a'_{\{0\}} & + & m'b_{\{0\}} & + & ck'_{\{0\}} & + & e'r_{\{0\}} \\
 & & 7 & & 8 & & 9 & & 10 \\
 & + & h_{\{1\}}n_{\{0\}} & + & b'k_{\{0\}} & + & r'_{\{1\}}d'_{\{0\}} & + & m_{\{1\}}l'_{\{0\}};
 \end{array}$$

$$\begin{array}{cccccccc}
 1 & & 5 & & 6 & & 8 & & 4 & & 9 & & 3 & & 10 & & 2 & & 7 \\
 ec' & + & ck' & + & e'r & + & b'k & + & m'b & + & r'd' & + & da' & + & ml' & + & ln' & + & hn \\
 - & - & = & - & = & - & = & - & = & - & = & - & = & = & - & = & - & =
 \end{array}$$

¶ a'h_{0} + h_{1}, i.e. ¶ h_{1}a'_{0}

i.e. I always avoid a kangaroo.

pg164

NOTES.

(A) [See p. 80].

One of the favourite objections, brought against the Science of Logic by its detractors, is that a Syllogism has no real validity as an argument, since it involves the Fallacy of Petitio Principii (i.e. "Begging the Question", the essence of which is that the whole Conclusion is involved in one of the Premises).

This formidable objection is refuted, with beautiful clearness and simplicity, by these three Diagrams, which show us that, in each of the three Figures, the Conclusion is really involved in the two Premises taken together, each contributing its share.

Thus, in Fig. I., the Premiss xm_{0} empties the Inner Cell of the N.W. Quarter, while the Premiss ym_{0} empties its Outer Cell. Hence it needs the two Premises to empty the whole of the N.W. Quarter, and thus to prove the Conclusion xy_{0}.

Symbolic Logic

Again, in Fig. II., the Premiss $xm_{\{0\}}$ empties the Inner Cell of the N.W. Quarter. The Premiss $ym_{\{1\}}$ merely tells us that the Inner Portion of the W. Half is occupied, so that we may place a 'I' in it, somewhere; but, if this were the whole of our information, we should not know in which Cell to place it, so that it would have to 'sit on the fence': it is only when we learn, from the other Premiss, that the upper of these two Cells is empty, that we feel authorised to place the 'I' in the lower Cell, and thus to prove the Conclusion $x'y_{\{1\}}$.

Lastly, in Fig. III., the information, that m exists, merely authorises us to place a 'I' somewhere in the Inner Square----but it has large choice of fences to sit upon! It needs the Premiss $xm_{\{0\}}$ to drive it out of the N. Half of that Square; and it needs the Premiss $ym_{\{0\}}$ to drive it out of the W. Half. Hence it needs the two Premisses to drive it into the Inner Portion of the S.E. Quarter, and thus to prove the Conclusion $x'y'_{\{1\}}$.

pg165

APPENDIX,

ADDRESSED TO TEACHERS.

§ 1.

Introductory.

There are several matters, too hard to discuss with Learners, which nevertheless need to be explained to any Teachers, into whose hands this book may fall, in order that they may thoroughly understand what my Symbolic Method is, and in what respects it differs from the many other Methods already published.

These matters are as follows:--

- The "Existential Import" of Propositions.
- The use of "is-not" (or "are-not") as a Copula.
- The theory "two Negative Premisses prove nothing."
- Euler's Method of Diagrams.
- Venn's Method of Diagrams.
- My Method of Diagrams.
- The Solution of a Syllogism by various Methods.
- My Method of treating Syllogisms and Sorites.
- Some account of Parts II, III.

§ 2.

The "Existential Import" of Propositions.

The writers, and editors, of the Logical text-books which run in the ordinary grooves----to whom I shall hereafter refer by the (I hope inoffensive) title "The Logicians"----take, on this subject, what seems to me to be a more humble position than is at all necessary. They speak of the Copula of a Proposition "with bated breath", almost as if it were a living, conscious Entity, capable of declaring for itself what it chose to mean, and that we, poor human creatures, had nothing to do but to ascertain what was its sovereign will and pleasure, and submit to it.

pg166

In opposition to this view, I maintain that any writer of a book is fully authorised in attaching any meaning he likes to any word or phrase he intends to use. If I find an author saying, at the beginning of his

Symbolic Logic

book, "Let it be understood that by the word 'black' I shall always mean 'white', and that by the word 'white' I shall always mean 'black,'" I meekly accept his ruling, however injudicious I may think it.

And so, with regard to the question whether a Proposition is or is not to be understood as asserting the existence of its Subject, I maintain that every writer may adopt his own rule, provided of course that it is consistent with itself and with the accepted facts of Logic.

Let us consider certain views that may logically be held, and thus settle which of them may conveniently be held; after which I shall hold myself free to declare which of them I intend to hold.

The kinds of Propositions, to be considered, are those that begin with "some", with "no", and with "all". These are usually called Propositions "in I", "in E", and "in A".

First, then, a Proposition in I may be understood as asserting, or else as not asserting, the existence of its Subject. (By "existence" I mean of course whatever kind of existence suits its nature. The two Propositions, "dreams exist" and "drums exist", denote two totally different kinds of "existence". A dream is an aggregate of ideas, and exists only in the mind of a dreamer; whereas a drum is an aggregate of wood and parchment, and exists in the hands of a drummer.)

First, let us suppose that I "asserts" (i.e. "asserts the existence of its Subject").

Here, of course, we must regard a Proposition in A as making the same assertion, since it necessarily contains a Proposition in I.

We now have I and A "asserting". Does this leave us free to make what supposition we choose as to E? My answer is "No. We are tied down to the supposition that E does not assert." This can be proved as follows:--

If possible, let E "assert". Then (taking x, y, and z to represent Attributes) we see that, if the Proposition "No xy are z" be true, some things exist with the Attributes x and y: i.e. "Some x are y."

Also we know that, if the Proposition "Some xy are z" be true, the same result follows. pg167

But these two Propositions are Contradictories, so that one or other of them must be true. Hence this result is always true: i.e. the Proposition "Some x are y" is always true!

Quod est absurdum. (See Note (A), p. 195).

We see, then, that the supposition "I asserts" necessarily leads to "A asserts, but E does not". And this is the first of the various views that may conceivably be held.

Next, let us suppose that I does not "assert." And, along with this, let us take the supposition that E does "assert."

Hence the Proposition "No x are y" means "Some x exist, and none of them are y": i.e. "all of them are not-y," which is a Proposition in A. We also know, of course, that the Proposition "All x are not-y" proves "No x are y." Now two Propositions, each of which proves the other, are equivalent. Hence every Proposition in A is equivalent to one in E, and therefore "asserts".

Hence our second conceivable view is "E and A assert, but I does not."

This view does not seem to involve any necessary contradiction with

Symbolic Logic

itself or with the accepted facts of Logic. But, when we come to test it, as applied to the actual facts of life, we shall find I think, that it fits in with them so badly that its adoption would be, to say the least of it, singularly inconvenient for ordinary folk.

Let me record a little dialogue I have just held with my friend Jones, who is trying to form a new Club, to be regulated on strictly Logical principles.

Author. "Well, Jones! Have you got your new Club started yet?"

Jones (rubbing his hands). "You'll be glad to hear that some of the Members (mind, I only say 'some') are millionaires! Rolling in gold, my boy!"

Author. "That sounds well. And how many Members have entered?"

Jones (staring). "None at all. We haven't got it started yet. What makes you think we have?"

Author. "Why, I thought you said that some of the Members----"

pg168

Jones (contemptuously). "You don't seem to be aware that we're working on strictly Logical principles. A Particular Proposition does not assert the existence of its Subject. I merely meant to say that we've made a Rule not to admit any Members till we have at least three Candidates whose incomes are over ten thousand a year!"

Author. "Oh, that's what you meant, is it? Let's hear some more of your Rules."

Jones. "Another is, that no one, who has been convicted seven times of forgery, is admissible."

Author. "And here, again, I suppose you don't mean to assert there are any such convicts in existence?"

Jones. "Why, that's exactly what I do mean to assert! Don't you know that a Universal Negative asserts the existence of its Subject? Of course we didn't make that Rule till we had satisfied ourselves that there are several such convicts now living."

The Reader can now decide for himself how far this second conceivable view would fit in with the facts of life. He will, I think, agree with me that Jones' view, of the 'Existential Import' of Propositions, would lead to some inconvenience.

Thirdly, let us suppose that neither I nor E "asserts".

Now the supposition that the two Propositions, "Some x are y" and "No x are not-y", do not "assert", necessarily involves the supposition that "All x are y" does not "assert", since it would be absurd to suppose that they assert, when combined, more than they do when taken separately.

Hence the third (and last) of the conceivable views is that neither I, nor E, nor A, "asserts".

The advocates of this third view would interpret the Proposition "Some x are y" to mean "If there were any x in existence, some of them would be y"; and so with E and A.

It admits of proof that this view, as regards A, conflicts with the accepted facts of Logic.

Let us take the Syllogism Darapti, which is universally accepted as valid. Its form is

Symbolic Logic

"All m are x;
All m are y.
.'. Some y are x".

pg169

This they would interpret as follows:--

"If there were any m in existence, all of them would be x;
If there were any m in existence, all of them would be y.
.'. If there were any y in existence, some of them
would be x".

That this conclusion does not follow has been so briefly and clearly explained by Mr. Keynes (in his "Formal Logic", dated 1894, pp. 356, 357), that I prefer to quote his words:--

"_Let no proposition imply the existence either of its subject or of its predicate._

"Take, as an example, a syllogism in Darapti:--

'_All M is P_,
All M is S,
.'. Some S is P.'

"Taking S, M, P, as the minor, middle, and major terms respectively, the conclusion will imply that, if there is an S, there is some P. Will the premisses also imply this? If so, then the syllogism is valid; but not otherwise.

"The conclusion implies that if S exists P exists; but, consistently with the premisses, S may be existent while M and P are both non-existent. An implication is, therefore, contained in the conclusion, which is not justified by the premisses."

This seems to me entirely clear and convincing. Still, "to make sicker", I may as well throw the above (soi-disant) syllogism into a concrete form, which will be within the grasp of even a non-logical Reader.

Let us suppose that a Boys' School has been set up, with the following system of Rules:--

"All boys in the First (the highest) Class are to do French, Greek, and Latin. All in the Second Class are to do Greek only. All in the Third Class are to do Latin only."

Suppose also that there are boys in the Third Class, and in the Second; but that no boy has yet risen into the First.

It is evident that there are no boys in the School doing French: still we know, by the Rules, what would happen if there were any.

pg170

We are authorised, then, by the Data, to assert the following two Propositions:--

"If there were any boys doing French, all of them would be doing Greek;
If there were any boys doing French, all of them would be doing Latin."

And the Conclusion, according to "The Logicians" would be

"If there were any boys doing Latin, some of them would be doing Greek."

Here, then, we have two true Premisses and a false Conclusion (since we know that there are boys doing Latin, and that none of them are doing Greek). Hence the argument is invalid.

Symbolic Logic

Similarly it may be shown that this "non-existential" interpretation destroys the validity of _Disamis_, _Datisi_, _Felapton_, and _Fresison_.

Some of "The Logicians" will, no doubt, be ready to reply "But we are not _Aldrichians_! Why should _we_ be responsible for the validity of the Syllogisms of so antiquated an author as Aldrich?"

Very good. Then, for the _special_ benefit of these "friends" of mine (with what ominous emphasis that name is sometimes used! "I must have a private interview with _you_, my young _friend_," says the bland Dr. Birch, "in my library, at 9 a.m. tomorrow. And you will please to be _punctual_!"), for their _special_ benefit, I say, I will produce _another_ charge against this "non-existential" interpretation.

It actually invalidates the ordinary Process of "Conversion", as applied to Proposition in '_I_'.

Every logician, Aldrichian or otherwise, accepts it as an established fact that "Some x are y" may be legitimately converted into "Some y are x."

But is it equally clear that the Proposition "If there _were_ any x, some of them _would_ be y" may be legitimately converted into "If there _were_ any y, some of them would be x"? I trow not.

The example I have already used----of a Boys' School with a non-existent First Class----will serve admirably to illustrate this new flaw in the theory of "The Logicians."

Let us suppose that there is yet _another_ Rule in this School, viz. ^{pg171} "In each Class, at the end of the Term, the head boy and the second boy shall receive prizes."

This Rule entirely authorises us to assert (in the sense in which "The Logicians" would use the words) "Some boys in the First Class will receive prizes", for this simply means (according to them) "If there _were_ any boys in the First Class, some of them _would_ receive prizes."

Now the Converse of this Proposition is, of course, "Some boys, who will receive prizes, are in the First Class", which means (according to "The Logicians") "If there _were_ any boys about to receive prizes, some of them _would_ be in the First Class" (which Class we know to be _empty_).

Of this Pair of Converse Propositions, the first is undoubtedly _true_: the second, _as_ undoubtedly, _false_.

It is always sad to see a batsman knock down his own wicket: one pities him, as a man and a brother, but, as a _cricketer_, one can but pronounce him "Out!"

We see, then, that, among all the conceivable views we have here considered, there are only _two_ which can _logically_ be held, viz.

I and _A_ "assert", but _E_ does not.
E and _A_ "assert", but _I_ does not.

The _second_ of these I have shown to involve great practical inconvenience.

The _first_ is the one adopted in this book. (See p. 19.)

Some further remarks on this subject will be found in Note (B), at p. 196.

Symbolic Logic

§ 3.

The use of "is-not" (or "are-not") as a Copula.

Is it better to say "John is-not in-the-house" or "John is not-in-the-house"? "Some of my acquaintances are-not men-I-should-like-to-be-seen-with" or "Some of my acquaintances are men-I-should-not-like-to-be-seen-with"? That is the sort of question we have now to discuss.

pg172

This is no question of Logical Right and Wrong: it is merely a matter of taste, since the two forms mean exactly the same thing. And here, again, "The Logicians" seem to me to take much too humble a position. When they are putting the final touches to the grouping of their Proposition, just before the curtain goes up, and when the Copula----always a rather fussy 'heavy father', asks them "Am I to have the 'not', or will you tack it on to the Predicate?" they are much too ready to answer, like the subtle cab-driver, "Leave it to you, Sir!" The result seems to be, that the grasping Copula constantly gets a "not" that had better have been merged in the Predicate, and that Propositions are differentiated which had better have been recognised as precisely similar. Surely it is simpler to treat "Some men are Jews" and "Some men are Gentiles" as being both of them, affirmative Propositions, instead of translating the latter into "Some men are-not Jews", and regarding it as a negative Propositions?

The fact is, "The Logicians" have somehow acquired a perfectly morbid dread of negative Attributes, which makes them shut their eyes, like frightened children, when they come across such terrible Propositions as "All not-x are y"; and thus they exclude from their system many very useful forms of Syllogisms.

Under the influence of this unreasoning terror, they plead that, in Dichotomy by Contradiction, the negative part is too large to deal with, so that it is better to regard each Thing as either included in, or excluded from, the positive part. I see no force in this plea; and the facts often go the other way. As a personal question, dear Reader, if you were to group your acquaintances into the two Classes, men that you would like to be seen with, and men that you would not like to be seen with, do you think the latter group would be so very much the larger of the two?

For the purposes of Symbolic Logic, it is so much the most convenient plan to regard the two sub-divisions, produced by Dichotomy, on the same footing, and to say, of any Thing, either that it "is" in the one, or that it "is" in the other, that I do not think any Reader of this book is likely to demur to my adopting that course.

pg173

§ 4.

The theory that "two Negative Premisses prove nothing".

This I consider to be another craze of "The Logicians", fully as morbid as their dread of a negative Attribute.

It is, perhaps, best refuted by the method of Instantia Contraria.

Take the following Pairs of Premisses:--

"None of my boys are conceited;
None of my girls are greedy".

"None of my boys are clever;
None but a clever boy could solve this problem".

Symbolic Logic

"None of my boys are learned;
Some of my boys are not choristers".

(This last Proposition is, in my system, an affirmative one, since I should read it "are not-choristers"; but, in dealing with "The Logicians," I may fairly treat it as a negative one, since they would read it "are-not choristers".)

If you, dear Reader, declare, after full consideration of these Pairs of Premisses, that you cannot deduce a Conclusion from any of them----why, all I can say is that, like the Duke in Patience, you "will have to be contented with our heart-felt sympathy"! [See Note (C), p. 196.]

§ 5.

Euler's Method of Diagrams.

Diagrams seem to have been used, at first, to represent Propositions only. In Euler's well-known Circles, each was supposed to contain a class, and the Diagram consisted of two circles, which exhibited the relations, as to inclusion and exclusion, existing between the two classes.

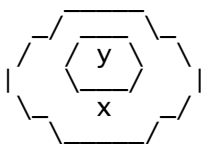

Thus, the Diagram, here given, exhibits the two Classes, whose respective Attributes are x and y, as so related to each other that the following Propositions are all simultaneously true:--"All x are y", "No x are not-y", "Some x are y", "Some y are not-x", "Some not-y are not-x", and, of course, the Converses of the last four.

pg174

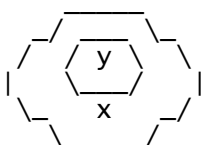

Similarly, with this Diagram, the following Propositions are true:--"All y are x", "No y are not-x", "Some y are x", "Some x are not-y", "Some not-x are not-y", and, of course, the Converses of the last four.

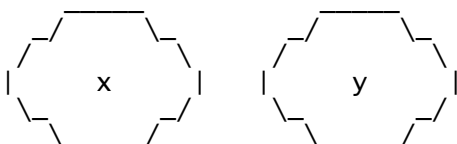

Similarly, with this Diagram, the following are true:--"All x are not-y", "All y are not-x", "No x are y", "Some x are not-y", "Some y are not-x", "Some not-x are not-y", and the Converses of the last four.

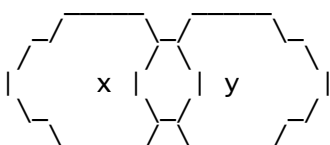

Symbolic Logic

Similarly, with this Diagram, the following are true:--"Some x are y", "Some x are not-y", "Some not-x are y", "Some not-x are not-y", and of course, their four Converses.

Note that all Euler's Diagrams assert "Some not-x are not-y." Apparently it never occurred to him that it might sometimes fail to be true!

Now, to represent "All x are y", the first of these Diagrams would suffice. Similarly, to represent "No x are y", the third would suffice. But to represent any Particular Proposition, at least three Diagrams would be needed (in order to include all the possible cases), and, for "Some not-x are not-y", all the four.

§ 6.

Venn's Method of Diagrams.

Let us represent "not-x" by "x'".

Mr. Venn's Method of Diagrams is a great advance on the above Method.

He uses the last of the above Diagrams to represent any desired relation between x and y, by simply shading a Compartment known to be empty, and placing a + in one known to be occupied.

Thus, he would represent the three Propositions "Some x are y", "No x are y", and "All x are y", as follows:--

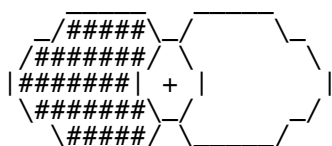
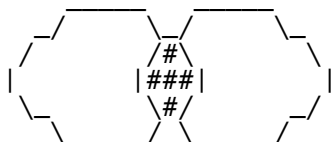
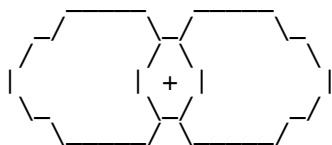

pg175

It will be seen that, of the four Classes, whose peculiar sets of Attributes are xy, xy', x'y, and x'y', only three are here provided with closed Compartments, while the fourth is allowed the rest of the Infinite Plane to range about in!

This arrangement would involve us in very serious trouble, if we ever attempted to represent "No x' are y'." Mr. Venn once (at p. 281) encounters this awful task; but evades it, in a quite masterly fashion, by the simple foot-note "we have not troubled to shade the outside of this diagram"!

To represent two Propositions (containing a common Term) together, a three-letter Diagram is needed. This is the one used by Mr. Venn.

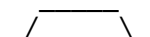

Symbolic Logic

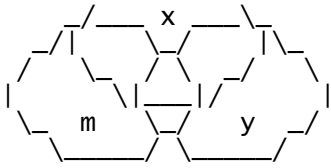

Here, again, we have only seven closed Compartments, to accommodate the eight Classes whose peculiar Sets of Attributes are xym , xym' , &c.

"With four terms in request," Mr. Venn says, "the most simple and symmetrical diagram seems to me that produced by making four ellipses intersect one another in the desired manner". This, however, provides only fifteen closed compartments.

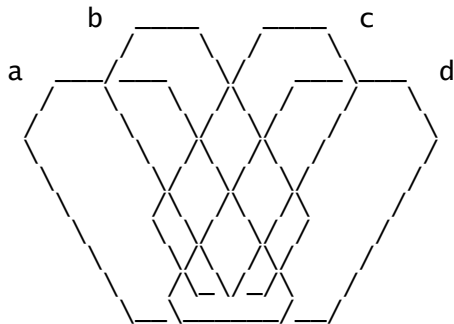

For five letters, "the simplest diagram I can suggest," Mr. Venn says, "is one like this (the small ellipse in the centre is to be regarded as a portion of the outside of c; i.e. its four component portions are inside b and d but are no part of c). It must be admitted that such a diagram is not quite so simple to draw as one might wish it to be; but then consider what the alternative is of one undertakes to deal with five terms and all their combinations--nothing short of the disagreeable task of writing out, or in some way putting before us, all the 32 combinations involved."

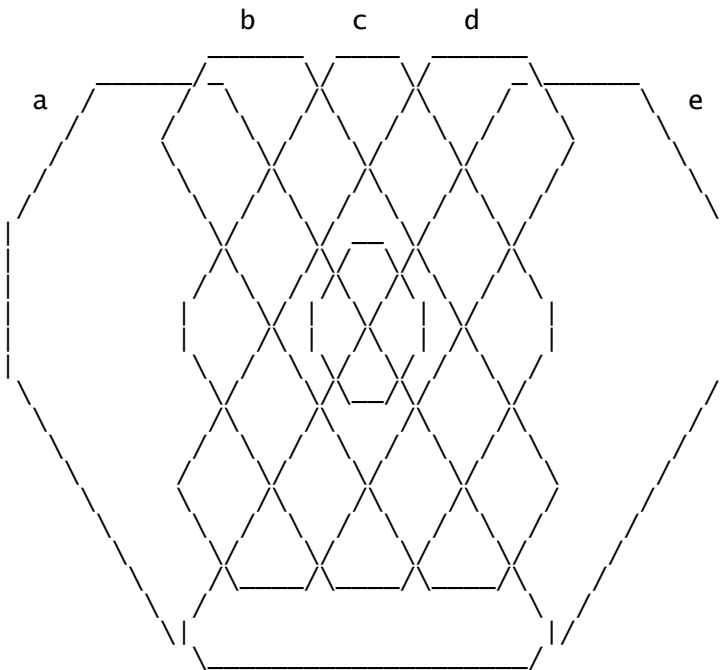

This Diagram gives us 31 closed compartments.

pg176

For six letters, Mr. Venn suggests that we might use two Diagrams, like the above, one for the f-part, and the other for the not-f-part, of

Symbolic Logic

all the other combinations. "This", he says, "would give the desired 64 subdivisions." This, however, would only give 62 closed Compartments, and one infinite area, which the two Classes, a'b'c'd'e'f and a'b'c'd'e'f', would have to share between them.

Beyond six letters Mr. Venn does not go.

§ 7.

My Method of Diagrams.

My Method of Diagrams resembles Mr. Venn's, in having separate Compartments assigned to the various Classes, and in marking these Compartments as occupied or as empty; but it differs from his Method, in assigning a closed area to the Universe of Discourse, so that the Class which, under Mr. Venn's liberal sway, has been ranging at will through Infinite Space, is suddenly dismayed to find itself "cabin'd, cribb'd, confined", in a limited Cell like any other Class! Also I use rectilinear, instead of curvilinear, Figures; and I mark an occupied Cell with a 'I' (meaning that there is at least one Thing in it), and an empty Cell with a 'O' (meaning that there is no Thing in it).

For two letters, I use this Diagram, in which the North Half is assigned to 'x', the South to 'not-x' (or 'x'), the West to y, and the East to y'. Thus the N.W. Cell contains the xy-Class, the N.E. Cell the xy'-Class, and so on.

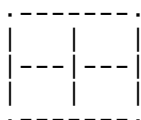

For three letters, I subdivide these four Cells, by drawing an Inner Square, which I assign to m, the Outer Border being assigned to m'. I thus get eight Cells that are needed to accommodate the eight Classes, whose peculiar Sets of Attributes are xym, xym', &c.

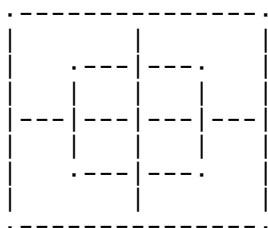

This last Diagram is the most complex that I use in the Elementary Part of my 'Symbolic Logic.' But I may as well take this opportunity of describing the more complex ones which will appear in Part II.

pg177

For four letters (which I call a, b, c, d) I use this Diagram; assigning the North Half to a (and of course the rest of the Diagram to a'), the west Half to b, the Horizontal Oblong to c, and the Upright oblong to d. We have now got 16 Cells.

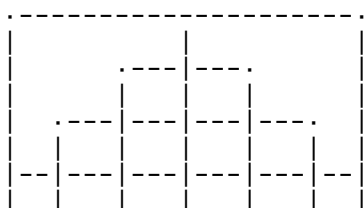

Symbolic Logic

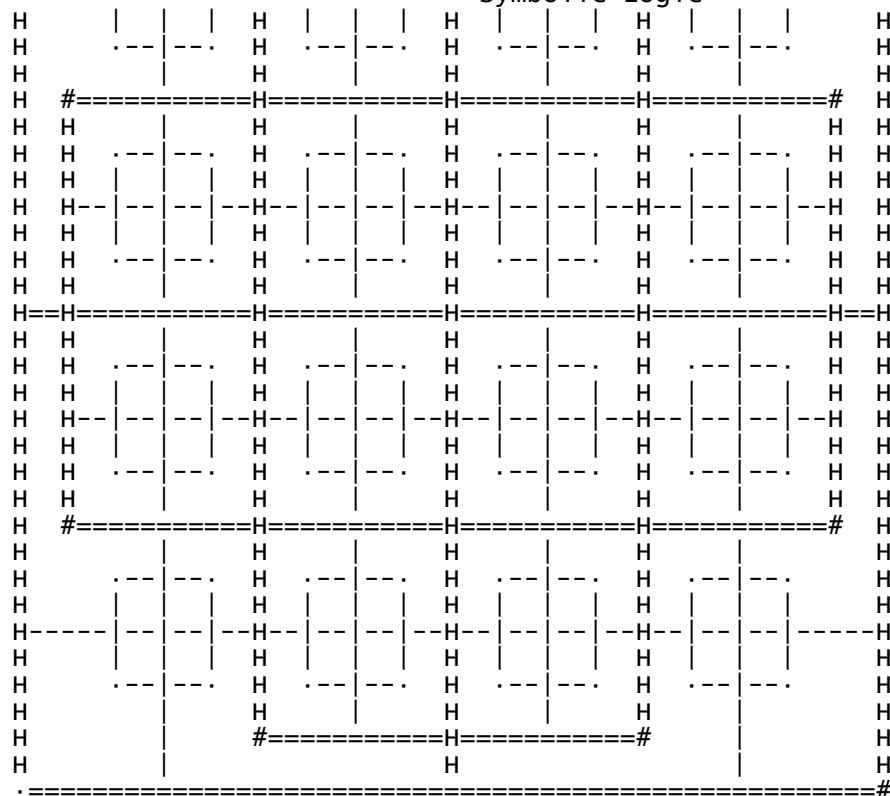

For eight letters (adding 1) I place, in each of the 16 Cells, a lattice, which is a reduced copy of the whole Diagram; and, just as the 16 large Cells of the whole Diagram are assigned to the 16 Classes $abcd$, $abcd'$, &c., so the 16 little Cells of each lattice are assigned to the 16 Classes $ehkl$, $ehkl'$, &c. Thus, the lattice in the N.W. corner serves to accommodate the 16 Classes $abcd'ehkl$, $abcd'eh'kl'$, &c. This Octoliteral Diagram (see next page) contains 256 Cells.

For nine letters, I place 2 Octoliteral Diagrams side by side, assigning one of them to m , and the other to m' . We have now got 512 Cells.

pg179

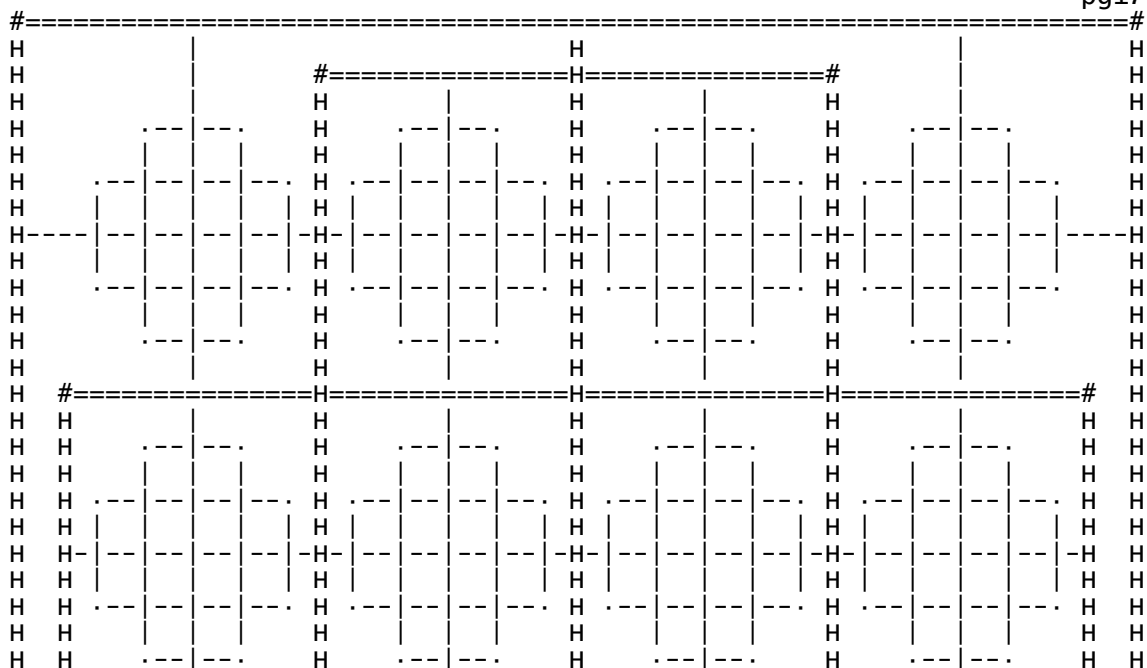

Symbolic Logic

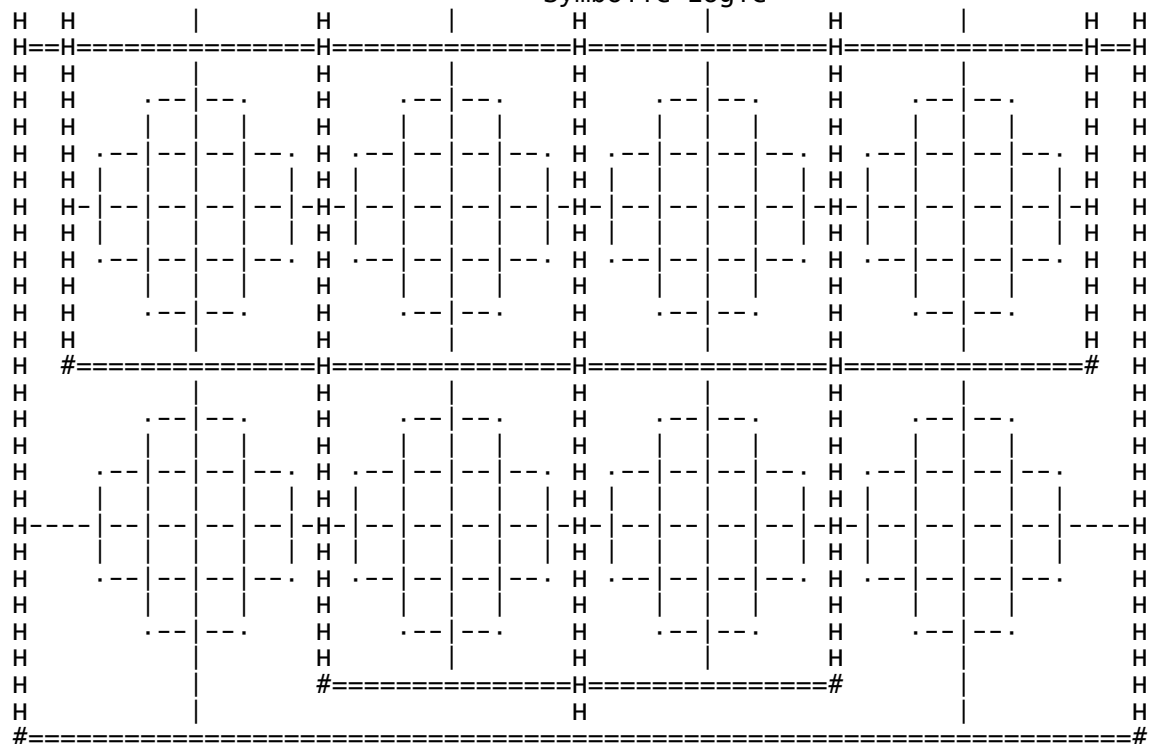

Finally, for ten letters, I arrange 4 Octoliteral Diagrams, like the above, in a square, assigning them to the 4 Classes mn, mn', m'n, m'n'. We have now got 1024 Cells.

§ 8.

Solution of a syllogism by various Methods.

The best way, I think, to exhibit the differences between these various Methods of solving Syllogisms, will be to take a concrete example, and solve it by each Method in turn. Let us take, as our example, No. 29 (see p. 102).

"No philosophers are conceited;
 Some conceited persons are not gamblers.
 ∴ Some persons, who are not gamblers, are not philosophers."

pg180

(1) Solution by ordinary Method.

These Premisses, as they stand, will give no Conclusion, as they are both negative.

If by 'Permutation' or 'Obversion', we write the Minor Premiss thus,

'Some conceited persons are not-gamblers,'

we can get a Conclusion in Fresison, viz.

"No philosophers are conceited;
 Some conceited persons are not-gamblers.
 ∴ Some not-gamblers are not philosophers"

This can be proved by reduction to Ferio, thus:--

"No conceited persons are philosophers;
 Some not-gamblers are conceited.

Symbolic Logic

.'. Some not-gamblers are not philosophers".

The validity of Ferio follows directly from the Axiom 'De Omni et Nullo'.

(2) Symbolic Representation.

Before proceeding to discuss other Methods of Solution, it is necessary to translate our Syllogism into an abstract form.

Let us take "persons" as our 'Universe of Discourse'; and let x = "philosophers", m = "conceited", and y = "gamblers."

Then the syllogism may be written thus:--

"No x are m;
Some m are y'.
.'. Some y' are x'."

(3) Solution by Euler's Method of Diagrams.

The Major Premiss requires only one Diagram, viz.

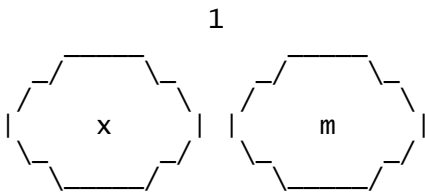

The Minor requires three, viz.

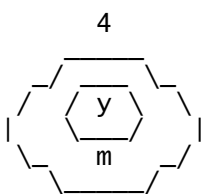
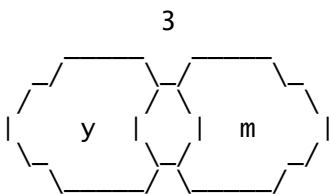
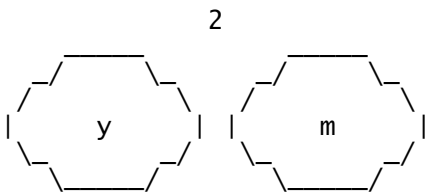

The combination of Major and Minor, in every possible way requires nine, viz.

Figs. 1 and 2 give

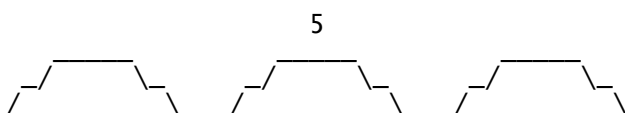

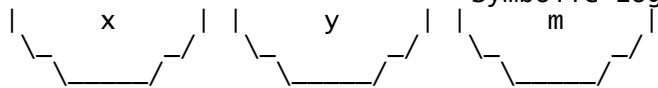

6

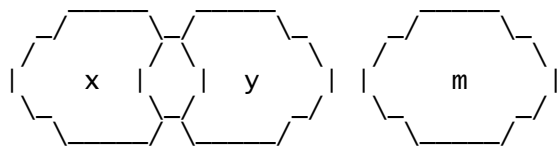

7

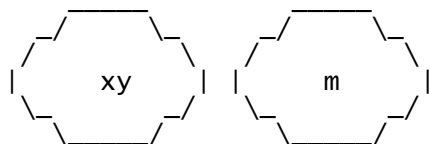

8

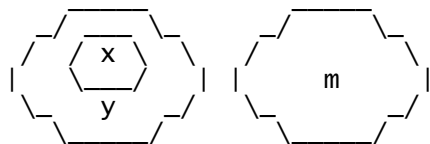

9



Figs. 1 and 3 give

10

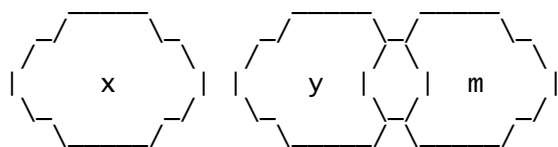

11

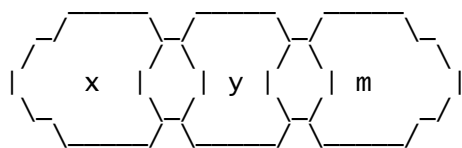

12

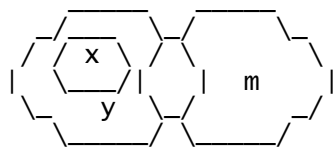

Figs. 1 and 4 give

13

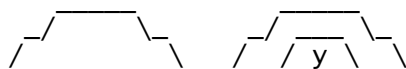

Symbolic Logic

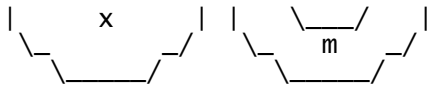

From this group (Figs. 5 to 13) we have, by disregarding *m*, to find the relation of *x* and *y*. On examination we find that Figs. 5, 10, 13 express the relation of entire mutual exclusion; that Figs. 6, 11 express partial inclusion and partial exclusion; that Fig. 7 expresses coincidence; that Figs. 8, 12 express entire inclusion of *x* in *y*; and that Fig. 9 expresses entire inclusion of *y* in *x*.

pg182

We thus get five Biliteral Diagrams for *x* and *y*, viz.

14

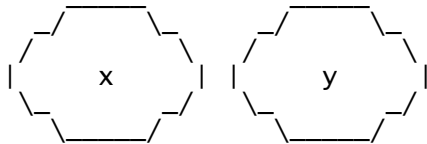

15

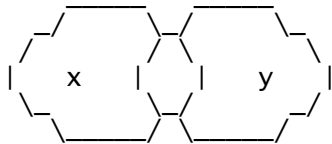

16

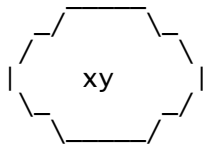

17

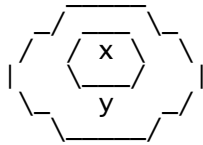

18

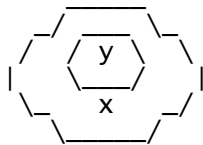

where the only Proposition, represented by them all, is "Some not-*y* are not-*x*," i.e. "Some persons, who are not gamblers, are not philosophers"----a result which Euler would hardly have regarded as a valuable one, since he seems to have assumed that a Proposition of this form is always true!

(4) Solution by Venn's Method of Diagrams.

The following solution has been kindly supplied to me Mr. Venn himself.

"The Minor Premiss declares that some of the constituents in my' must be saved: mark these constituents with a cross.

Symbolic Logic

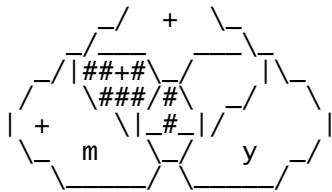

The Major declares that all xm must be destroyed; erase it.

Then, as some my' is to be saved, it must clearly be my'x'. That is, there must exist my'x'; or eliminating m, y'x'. In common phraseology, 'Some y' are x', or, 'Some not-gamblers are not-philosophers.'

pg183

(5) Solution by my Method of Diagrams.

The first Premiss asserts that no xm exist: so we mark the xm-Compartment as empty, by placing a '0' in each of its Cells.

The second asserts that some my' exist: so we mark the my'-Compartment as occupied, by placing a 'I' in its only available Cell.

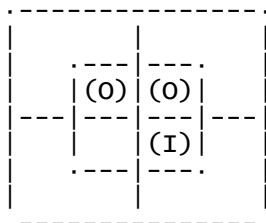

The only information, that this gives us as to x and y, is that the x'y'-Compartment is occupied, i.e. that some x'y' exist.

Hence "Some x' are y'": i.e. "Some persons, who are not philosophers, are not gamblers".

(6) Solution by my Method of Subscripts.

$$xm_{\{0\}} + my'_{\{1\}} \Rightarrow x'y'_{\{1\}}$$

i.e. "Some persons, who are not philosophers, are not gamblers."

§ 9.

My Method of treating Syllogisms and Sorites.

Of all the strange things, that are to be met with in the ordinary text-books of Formal Logic, perhaps the strangest is the violent contrast one finds to exist between their ways of dealing with these two subjects. While they have elaborately discussed no less than nineteen different forms of Syllogisms---each with its own special and exasperating Rules, while the whole constitute an almost useless machine, for practical purposes, many of the Conclusions being incomplete, and many quite legitimate forms being ignored---they have limited Sorites to two forms only, of childish simplicity; and these they have dignified with special names, apparently under the impression that no other possible forms existed!

As to Syllogisms, I find that their nineteen forms, with about a score of others which they have ignored, can all be arranged under three forms, each with a very simple Rule of its own; and the only question

Symbolic Logic

the Reader has to settle, in working any one of the 101 Examples given at p. 101 of this book, is "Does it belong to Fig. I., II., or III.?"

pg184

As to Sorites, the only two forms, recognised by the text-books, are the Aristotelian, whose Premises are a series of Propositions in A, so arranged that the Predicate of each is the Subject of the next, and the Goclenian, whose Premises are the very same series, written backwards. Goclenius, it seems, was the first who noticed the startling fact that it does not affect the force of a Syllogism to invert the order of its Premises, and who applied this discovery to a Sorites. If we assume (as surely we may?) that he is the same man as that transcendent genius who first noticed that 4 times 5 is the same thing as 5 times 4, we may apply to him what somebody (Edmund Yates, I think it was) has said of Tupper, viz., "here is a man who, beyond all others of his generation, has been favoured with Glimpses of the Obvious!"

These puerile----not to say infantine----forms of a Sorites I have, in this book, ignored from the very first, and have not only admitted freely Propositions in E, but have purposely stated the Premises in random order, leaving to the Reader the useful task of arranging them, for himself, in an order which can be worked as a series of regular Syllogisms. In doing this, he can begin with any one of them he likes.

I have tabulated, for curiosity, the various orders in which the Premises of the Aristotelian Sorites

1. All a are b;
 2. All b are c;
 3. All c are d;
 4. All d are e;
 5. All e are h.
- .'. All a are h.

may be syllogistically arranged, and I find there are no less than sixteen such orders, viz., 12345, 21345, 23145, 23415, 23451, 32145, 32415, 32451, 34215, 34251, 34521, 43215, 43251, 43521, 45321, 54321. Of these the first and the last have been dignified with names; but the other fourteen----first enumerated by an obscure writer on Logic, towards the end of the Nineteenth Century----remain without a name!

pg185

§ 10.

Some account of Parts II, III.

In Part II. will be found some of the matters mentioned in this Appendix, viz., the "Existential Import" of Propositions, the use of a negative Copula, and the theory that "two negative Premises prove nothing." I shall also extend the range of Syllogisms, by introducing Propositions containing alternatives (such as "Not-all x are y"), Propositions containing 3 or more Terms (such as "All ab are c", which, taken along with "Some bc' are d", would prove "Some d are a'"), &c. I shall also discuss Sorites containing Entities, and the very puzzling subjects of Hypotheticals and Dilemmas. I hope, in the course of Part II., to go over all the ground usually traversed in the text-books used in our Schools and Universities, and to enable my Readers to solve Problems of the same kind as, and far harder than, those that are at present set in their Examinations.

In Part III. I hope to deal with many curious and out-of-the-way subjects, some of which are not even alluded to in any of the treatises I have met with. In this Part will be found such matters as the Analysis of Propositions into their Elements (let the Reader, who has never gone into this branch of the subject, try to make out for himself what additional Proposition would be needed to convert "Some a are b" into "Some a are bc"), the treatment of Numerical and Geometrical Problems, the construction of Problems, and the solution of Syllogisms and Sorites

Symbolic Logic

containing Propositions more complex than any that I have used in Part II.

I will conclude with eight Problems, as a taste of what is coming in Part II. I shall be very glad to receive, from any Reader, who thinks he has solved any one of them (more especially if he has done so without using any Method of Symbols), what he conceives to be its complete Conclusion.

It may be well to explain what I mean by the complete Conclusion of a Syllogism or a Sorites. I distinguish their Terms as being of two kinds----those which can be eliminated (e.g. the Middle Term of a Syllogism), which I call the "Eliminands," and those which cannot, which I call the "Retinends"; and I do not call the Conclusion complete, unless it states all the relations among the Retinends only, which can be deduced from the Premises.

pg186

1.

All the boys, in a certain School, sit together in one large room every evening. They are of no less than five nationalities----English, Scotch, Welsh, Irish, and German. One of the Monitors (who is a great reader of Wilkie Collins' novels) is very observant, and takes MS. notes of almost everything that happens, with the view of being a good sensational witness, in case any conspiracy to commit a murder should be on foot. The following are some of his notes:--

- (1) Whenever some of the English boys are singing "Rule Britannia", and some not, some of the Monitors are wide-awake;
- (2) Whenever some of the Scotch are dancing reels, and some of the Irish fighting, some of the Welsh are eating toasted cheese;
- (3) Whenever all the Germans are playing chess, some of the Eleven are not oiling their bats;
- (4) Whenever some of the Monitors are asleep, and some not, some of the Irish are fighting;
- (5) Whenever some of the Germans are playing chess, and none of the Scotch are dancing reels, some of the Welsh are not eating toasted cheese;
- (6) Whenever some of the Scotch are not dancing reels, and some of the Irish not fighting, some of the Germans are playing chess;
- (7) Whenever some of the Monitors are awake, and some of the Welsh are eating toasted cheese, none of the Scotch are dancing reels;
- (8) Whenever some of the Germans are not playing chess, and some of the Welsh are not eating toasted cheese, none of the Irish are fighting;

pg187

- (9) Whenever all the English are singing "Rule Britannia," and some of the Scotch are not dancing reels, none of the Germans are playing chess;
- (10) Whenever some of the English are singing "Rule Britannia", and some of the Monitors are asleep, some of the Irish are not fighting;
- (11) Whenever some of the Monitors are awake, and some of the Eleven are not oiling their bats, some of the Scotch are dancing reels;
- (12) Whenever some of the English are singing "Rule Britannia", and some of the Scotch are not dancing reels, * * * *

Here the MS. breaks off suddenly. The Problem is to complete the

Symbolic Logic

sentence, if possible.

[N.B. In solving this Problem, it is necessary to remember that the Proposition "All x are y" is a Double Proposition, and is equivalent to "Some x are y, and none are y'." See p. 17.]

2.

- (1) A logician, who eats pork-chops for supper, will probably lose money;
- (2) A gambler, whose appetite is not ravenous, will probably lose money;
- (3) A man who is depressed, having lost money and being likely to lose more, always rises at 5 a.m.;
- (4) A man, who neither gambles nor eats pork-chops for supper, is sure to have a ravenous appetite;
- (5) A lively man, who goes to bed before 4 a.m., had better take to cab-driving;
- (6) A man with a ravenous appetite, who has not lost money and does not rise at 5 a.m., always eats pork-chops for supper;
- (7) A logician, who is in danger of losing money, had better take to cab-driving;
- (8) An earnest gambler, who is depressed though he has not lost money, is in no danger of losing any;
- (9) A man, who does not gamble, and whose appetite is not ravenous, is always lively;
- (10) A lively logician, who is really in earnest, is in no danger of losing money;
- (11) A man with a ravenous appetite has no need to take to cab-driving, if he is really in earnest;
- (12) A gambler, who is depressed though in no danger of losing money, sits up till 4 a.m.
- (13) A man, who has lost money and does not eat pork-chops for supper, had better take to cab-driving, unless he gets up at 5 a.m.
- (14) A gambler, who goes to bed before 4 a.m., need not take to cab-driving, unless he has a ravenous appetite;
- (15) A man with a ravenous appetite, who is depressed though in no danger of losing, is a gambler.

pg188

Univ. "men"; a = earnest; b = eating pork-chops for supper;
 c = gamblers; d = getting up at 5; e = having lost money; h = having a ravenous appetite; k = likely to lose money; l = lively; m = logicians;
 n = men who had better take to cab-driving; r = sitting up till 4.

[N.B. In this Problem, clauses, beginning with "though", are intended to be treated as essential parts of the Propositions in which they occur, just as if they had begun with "and".]

3.

- (1) when the day is fine, I tell Froggy "You're quite the dandy, old chap!";

Symbolic Logic

(2) Whenever I let Froggy forget that £10 he owes me, and he begins to strut about like a peacock, his mother declares "He shall not go out a-wooing!";

(3) Now that Froggy's hair is out of curl, he has put away his gorgeous waistcoat;

(4) Whenever I go out on the roof to enjoy a quiet cigar, I'm sure to discover that my purse is empty;

(5) When my tailor calls with his little bill, and I remind Froggy of that £10 he owes me, he does not grin like a hyæna;

pg189

(6) When it is very hot, the thermometer is high;

(7) When the day is fine, and I'm not in the humour for a cigar, and Froggy is grinning like a hyæna, I never venture to hint that he's quite the dandy;

(8) When my tailor calls with his little bill and finds me with an empty purse, I remind Froggy of that £10 he owes me;

(9) My railway-shares are going up like anything!

(10) When my purse is empty, and when, noticing that Froggy has got his gorgeous waistcoat on, I venture to remind him of that £10 he owes me, things are apt to get rather warm;

(11) Now that it looks like rain, and Froggy is grinning like a hyæna, I can do without my cigar;

(12) When the thermometer is high, you need not trouble yourself to take an umbrella;

(13) When Froggy has his gorgeous waistcoat on, but is not strutting about like a peacock, I betake myself to a quiet cigar;

(14) When I tell Froggy that he's quite the dandy, he grins like a hyæna;

(15) When my purse is tolerably full, and Froggy's hair is one mass of curls, and when he is not strutting about like a peacock, I go out on the roof;

(16) When my railway-shares are going up, and when it is chilly and looks like rain, I have a quiet cigar;

(17) When Froggy's mother lets him go a-wooing, he seems nearly mad with joy, and puts on a waistcoat that is gorgeous beyond words;

(18) When it is going to rain, and I am having a quiet cigar, and Froggy is not intending to go a-wooing, you had better take an umbrella;

(19) When my railway-shares are going up, and Froggy seems nearly mad with joy, that is the time my tailor always chooses for calling with his little bill;

(20) When the day is cool and the thermometer low, and I say nothing to Froggy about his being quite the dandy, and there's not the ghost of a grin on his face, I haven't the heart for my cigar!

pg190

4.

(1) Any one, fit to be an M.P., who is not always speaking, is a public benefactor;

(2) Clear-headed people, who express themselves well, have had a good

Symbolic Logic

education;

- (3) A woman, who deserves praise, is one who can keep a secret;
- (4) People, who benefit the public, but do not use their influence for good purpose, are not fit to go into Parliament;
- (5) People, who are worth their weight in gold and who deserve praise, are always unassuming;
- (6) Public benefactors, who use their influence for good objects, deserve praise;
- (7) People, who are unpopular and not worth their weight in gold, never can keep a secret;
- (8) People, who can talk for ever and are fit to be Members of Parliament, deserve praise;
- (9) Any one, who can keep a secret and who is unassuming, is a never-to-be-forgotten public benefactor;
- (10) A woman, who benefits the public, is always popular;
- (11) People, who are worth their weight in gold, who never leave off talking, and whom it is impossible to forget, are just the people whose photographs are in all the shop-windows;
- (12) An ill-educated woman, who is not clear-headed, is not fit to go into Parliament;
- (13) Any one, who can keep a secret and is not for ever talking, is sure to be unpopular;
- (14) A clear-headed person, who has influence and uses it for good objects, is a public benefactor;
- (15) A public benefactor, who is unassuming, is not the sort of person whose photograph is in every shop-window;
- (16) People, who can keep a secret and who use their influence for good purposes, are worth their weight in gold;
- (17) A person, who has no power of expression and who cannot influence others, is certainly not a woman;
- (18) People, who are popular and worthy of praise, either are public benefactors or else are unassuming.

pg191

Univ. "persons"; a = able to keep a secret; b = clear-headed; c = constantly talking; d = deserving praise; e = exhibited in shop-windows; h = expressing oneself well; k = fit to be an M.P.; l = influential; m = never-to-be-forgotten; n = popular; r = public benefactors; s = unassuming; t = using one's influence for good objects; v = well-educated; w = women; z = worth one's weight in gold.

5.

Six friends, and their six wives, are staying in the same hotel; and they all walk out daily, in parties of various size and composition. To ensure variety in these daily walks, they have agreed to observe the following Rules:--

- (1) If Acres is with (i.e. is in the same party with) his wife, and Barry with his, and Eden with Mrs. Hall, Cole must be with Mrs. Dix;
- (2) If Acres is with his wife, and Hall with his, and Barry with Mrs.

Symbolic Logic

Cole, Dix must not be with Mrs. Eden;

(3) If Cole and Dix and their wives are all in the same party, and Acres not with Mrs. Barry, Eden must not be with Mrs. Hall;

(4) If Acres is with his wife, and Dix with his, and Barry not with Mrs. Cole, Eden must be with Mrs. Hall;

(5) If Eden is with his wife, and Hall with his, and Cole with Mrs. Dix, Acres must not be with Mrs. Barry;

(6) If Barry and Cole and their wives are all in the same party, and Eden not with Mrs. Hall, Dix must be with Mrs. Eden.

The Problem is to prove that there must be, every day, at least one married couple who are not in the same party.

pg192

6.

After the six friends, named in Problem 5, had returned from their tour, three of them, Barry, Cole, and Dix, agreed, with two other friends of theirs, Lang and Mill, that the five should meet, every day, at a certain table d'hôte. Remembering how much amusement they had derived from their code of rules for walking-parties, they devised the following rules to be observed whenever beef appeared on the table:--

(1) If Barry takes salt, then either Cole or Lang takes one only of the two condiments, salt and mustard: if he takes mustard, then either Dix takes neither condiment, or Mill takes both.

(2) If Cole takes salt, then either Barry takes only one condiment, or Mill takes neither: if he takes mustard, then either Dix or Lang takes both.

(3) If Dix takes salt, then either Barry takes neither condiment or Cole take both: if he takes mustard, then either Lang or Mill takes neither.

(4) If Lang takes salt, then Barry or Dix takes only one condiment: if he takes mustard, then either Cole or Mill takes neither.

(5) If Mill takes salt, then either Barry or Lang takes both condiments: if he takes mustard, then either Cole or Dix takes only one.

The Problem is to discover whether these rules are compatible; and, if so, what arrangements are possible.

[N.B. In this Problem, it is assumed that the phrase "if Barry takes salt" allows of two possible cases, viz. (1) "he takes salt only"; (2) "he takes both condiments". And so with all similar phrases.

It is also assumed that the phrase "either Cole or Lang takes one only of the two condiments" allows three possible cases, viz. (1) "Cole takes one only, Lang takes both or neither"; (2) "Cole takes both or neither, Lang takes one only"; (3) "Cole takes one only, Lang takes one only". And so with all similar phrases.

It is also assumed that every rule is to be understood as implying the words "and vice versa." Thus the first rule would imply the addition "and, if either Cole or Lang takes only one condiment, then Barry takes salt."]

pg193

7.

(1) Brothers, who are much admired, are apt to be self-conscious;

Symbolic Logic

- (2) When two men of the same height are on opposite sides in Politics, if one of them has his admirers, so also has the other;
- (3) Brothers, who avoid general Society, look well when walking together;
- (4) Whenever you find two men, who differ in Politics and in their views of Society, and who are not both of them ugly, you may be sure that they look well when walking together;
- (5) Ugly men, who look well when walking together, are not both of them free from self-consciousness;
- (6) Brothers, who differs in Politics, and are not both of them handsome, never give themselves airs;
- (7) John declines to go into Society, but never gives himself airs;
- (8) Brothers, who are apt to be self-conscious, though not both of them handsome, usually dislike Society;
- (9) Men of the same height, who do not give themselves airs, are free from self-consciousness;
- (10) Men, who agree on questions of Art, though they differ in Politics, and who are not both of them ugly, are always admired;
- (11) Men, who hold opposite views about Art and are not admired, always give themselves airs;
- (12) Brothers of the same height always differ in Politics;
- (13) Two handsome men, who are neither both of them admired nor both of them self-conscious, are no doubt of different heights;
- (14) Brothers, who are self-conscious, and do not both of them like Society, never look well when walking together.

[N.B. See Note at end of Problem 2.]

pg194

8.

- (1) A man can always master his father;
- (2) An inferior of a man's uncle owes that man money;
- (3) The father of an enemy of a friend of a man owes that man nothing;
- (4) A man is always persecuted by his son's creditors;
- (5) An inferior of the master of a man's son is senior to that man;
- (6) A grandson of a man's junior is not his nephew;
- (7) A servant of an inferior of a friend of a man's enemy is never persecuted by that man;
- (8) A friend of a superior of the master of a man's victim is that man's enemy;
- (9) An enemy of a persecutor of a servant of a man's father is that man's friend.

The Problem is to deduce some fact about great-grandsons.

[N.B. In this Problem, it is assumed that all the men, here

Symbolic Logic

referred to, live in the same town, and that every pair of them are either "friends" or "enemies," that every pair are related as "senior and junior", "superior and inferior", and that certain pairs are related as "creditor and debtor", "father and son", "master and servant", "persecutor and victim", "uncle and nephew".]

9.

"Jack Sprat could eat no fat:
His wife could eat no lean:
And so, between them both,
They licked the platter clean."

Solve this as a Sorites-Problem, taking lines 3 and 4 as the Conclusion to be proved. It is permitted to use, as Premisses, not only all that is here asserted, but also all that we may reasonably understand to be implied.

pg195

NOTES TO APPENDIX.

(A) [See p. 167, line 6.]

It may, perhaps, occur to the Reader, who has studied Formal Logic that the argument, here applied to the Propositions I and E, will apply equally well to the Propositions I and A (since, in the ordinary text-books, the Propositions "All xy are z" and "Some xy are not z" are regarded as Contradictories). Hence it may appear to him that the argument might have been put as follows:--

"We now have I and A 'asserting.' Hence, if the Proposition 'All xy are z' be true, some things exist with the Attributes x and y: i.e. 'Some x are y.'

"Also we know that, if the Proposition 'Some xy are not-z' be true the same result follows.

"But these two Propositions are Contradictories, so that one or other of them must be true. Hence this result is always true: i.e. the Proposition 'Some x are y' is always true!

"Quod est absurdum. Hence I cannot assert."

This matter will be discussed in Part II; but I may as well give here what seems to me to be an irresistible proof that this view (that A and I are Contradictories), though adopted in the ordinary text-books, is untenable. The proof is as follows:--

With regard to the relationship existing between the Class 'xy' and the two Classes 'z' and 'not-z', there are four conceivable states of things, viz.

- | | | | |
|-----|----------------|-----|-----------------|
| (1) | Some xy are z, | and | some are not-z; |
| (2) | " | " | none |
| (3) | No xy | " | some |
| (4) | " | " | none |

Of these four, No. (2) is equivalent to "All xy are z", No. (3) is equivalent to "All xy are not-z", and No. (4) is equivalent to "No xy exist."

Now it is quite undeniable that, of these four states of things, each is, a priori, possible, some one must be true, and the other three

Symbolic Logic

must be false.

Hence the Contradictory to (2) is "Either (1) or (3) or (4) is true." Now the assertion "Either (1) or (3) is true" is equivalent to "Some xy are not-z"; and the assertion "(4) is true" is equivalent to "No xy exist." Hence the Contradictory to "All xy are z" may be expressed as the Alternative Proposition "Either some xy are not-z, or no xy exist," but not as the Categorical Proposition "Some y are not-z."

pg196

(B) [See p. 171, at end of Section 2.]

There are yet other views current among "The Logicians", as to the "Existential Import" of Propositions, which have not been mentioned in this Section.

One is, that the Proposition "some x are y" is to be interpreted, neither as "Some x exist and are y", nor yet as "If there were any x in existence, some of them would be y", but merely as "Some x can be y; i.e. the Attributes x and y are compatible". On this theory, there would be nothing offensive in my telling my friend Jones "Some of your brothers are swindlers"; since, if he indignantly retorted "what do you mean by such insulting language, you scoundrel?", I should calmly reply "I merely mean that the thing is conceivable----that some of your brothers might possibly be swindlers". But it may well be doubted whether such an explanation would entirely appease the wrath of Jones!

Another view is, that the Proposition "All x are y" sometimes implies the actual existence of x, and sometimes does not imply it; and that we cannot tell, without having it in concrete form, which interpretation we are to give to it. This view is, I think, strongly supported by common usage; and it will be fully discussed in Part II: but the difficulties, which it introduces, seem to me too formidable to be even alluded to in Part I, which I am trying to make, as far as possible, easily intelligible to mere beginners.

(C) [See p. 173, § 4.]

The three Conclusions are

"No conceited child of mine is greedy";
 "None of my boys could solve this problem";
 "Some unlearned boys are not choristers."

pg197

INDEX.

§ 1.

Tables.

I. Biliteral Diagram. Attributes of Classes, and Compartments, or Cells, assigned to them	25
II. do. Representation of Unilateral Propositions of Existence	34
III. do. Representation of Biliteral Propositions of Existence and of Relation	35
IV. Trilateral Diagram. Attributes of Classes, and Compartments, or Cells, assigned to them	42
V. do. Representation of Particular and Universal	

	Symbolic Logic	
Negative Propositions, of Existence and of Relation, in terms of x and m		46
VI. do. do., in terms of y and m		47
VII. do. Representation of Universal Affirmative Propositions of Relation, in terms of x and m		48
VIII. do. do. in terms of y and m		49
IX. Method of Subscripts. Formulæ and Rules for Syllogisms		78
§ 2.		
Words &c. explained.		
'Abstract' Proposition		59
'Adjuncts'		1
'Affirmative' Proposition		10
'Attributes'		1
'Bilateral' Diagram		22
" Proposition		27
'Class'		1½
Classes, arbitrary limits of		3½
" , subdivision of		4
'Classification'		1½
'Codivisional' Classes		3
'Complete' Conclusion of a Sorites		85
'Conclusion' of a Sorites		"
" " syllogism		56
'Concrete' Proposition		59
'Consequent' in a Sorites		85
" " syllogism		56
'Converse' Propositions		31
'Conversion' of a Proposition		"
'Copula' of a Proposition		9
'Definition'		6
'Dichotomy'		3½
'Differentia'		1½
'Division'		3
'Eliminands' of a Sorites		85
" " syllogism		56

pg198

Symbolic Logic

'Entity'	70
'Equivalent' Propositions	17
'Fallacy'	81
'Genus'	1½
'Imaginary' Class	"
" Name	4½
'Individual'	2
'Like', and 'Unlike', Signs of Terms	70
'Name'	4
'Negative' Proposition	10
'Normal' form of a Proposition	9
" " of Existence	11
" " of Relation	12
'Nullity'	70
'Partial' Conclusion of a Sorites	85
'Particular' Proposition	9
'Peculiar' Attributes	1½
'Predicate' of a Proposition	9
" of a Proposition of Existence	11
" " Relation	12
'Premisses' of a Sorites	85
" " syllogism	56
'Proposition'	8
" 'in _I_', 'in _E_', and 'in _A_'	9
" 'in terms of' certain Letters	27
" of Existence	11
" of Relation	12
'Real' Class	1½
'Retinends' of a Sorites	85
" " syllogism	56
'Sign of Quantity' in a Proposition	9
'Sitting on the Fence'	26
'Some', technical meaning of	8
'Sorites'	85

pg199

Symbolic Logic

'Species'	1½
'Subject' of a Proposition	9
" " of Existence	11
" " of Relation	12
'Subscripts' of Terms	70
'Syllogism'	56
Symbol ".'.."	"
" "+" and "¶"	70
'Terms' of a Proposition	9
'Things'	1
Translation of Proposition from 'concrete' to 'abstract'	59
" " 'abstract' to 'subscript'	72
'Triliteral' Diagram	39
'Underscoring' of letters	91
'Uniliteral' Proposition	27
'Universal' "	10
'Universe of Discourse' (or 'Univ.')	12
'Unreal' Class	1½
'Unreal' Name	4½

pg200

THE END.

px-1

WORKS BY LEWIS CARROLL.

* * * * *

PUBLISHED BY
MACMILLAN AND CO., LTD., LONDON.

* * * * *

ALICE'S ADVENTURES IN WONDERLAND. With Forty-two Illustrations by TENNIEL. (First published in 1865.) Cr. 8vo, cloth, gilt edges, price 6_s._ net. Eighty-sixth Thousand.

THE SAME; PEOPLE'S EDITION. (First published in 1887.) Cr. 8vo, cloth, price 2_s._ 6_d._ net. Forty-eighth Thousand.

Symbolic Logic

AVENTURES D'ALICE AU PAYS DES MERVEILLES. Traduit de l'Anglais par HENRI BUÉ. Ouvrage illustré de 42 Vignettes par JOHN TENNIEL. (First published in 1869.) Cr. 8vo, cloth, gilt edges, price 6_s._ net. Second Thousand.

Alice's Abenteuer im Wunderland. Aus dem Englischen von Antonie Zimmermann. Mit 42 Illustrationen von JOHN TENNIEL. (First published in 1869.) Crown 8vo, cloth, gilt edges, price 6_s._ net.

LE AVVENTURE D'ALICE NEL PAESE DELLE MERAVIGLIE. Tradotte dall' Inglese da T. PIETROCOLA-ROSSETTI. Con 42 Vignette di GIOVANNI TENNIEL. (First published in 1872.) Crown 8vo, cloth, gilt edges, price 6_s._ net.

ALICE'S ADVENTURES UNDER GROUND. Being a Facsimile of the original MS. Book, which was afterwards developed into "Alice's Adventures in Wonderland." with Thirty-seven Illustrations by the Author. (Begun, July 1862; finished, Feb. 1863; first published, in facsimile, in 1886.) Crown 8vo, cloth, gilt edges, price 4_s._ net. Third Thousand.

THE NURSERY "ALICE." Containing Twenty Coloured Enlargements from TENNIEL'S Illustrations to "Alice's Adventures in Wonderland." with text adapted to Nursery Readers. Cover designed by E. GERTRUDE THOMSON. (First published in 1890.) 4to, boards, price 1_s._ net. Eleventh Thousand.

px-2

THROUGH THE LOOKING-GLASS, AND WHAT ALICE FOUND THERE. With Fifty Illustration by TENNIEL. (First published in 1871.) Cr. 8vo, cloth, gilt edges, price 6_s._ net. Sixty-first Thousand.

THROUGH THE LOOKING-GLASS, AND WHAT ALICE FOUND THERE; PEOPLE'S EDITION. (First published in 1887.) Crown 8vo, cloth, gilt edges, price 2_s._ 6_d._ net. Thirtieth Thousand.

ALICE'S ADVENTURES IN WONDERLAND; AND THROUGH THE LOOKING-GLASS; PEOPLE'S EDITIONS. Both Books together in One Volume. (First published in 1887.) Crown 8vo, cloth, gilt edges, price 4_s._ 6_d._ net. Twelfth Thousand.

THE HUNTING OF THE SNARK. An Agony in Eight Fits. With Nine Illustrations, and two large gilt designs on cover, by HENRY HOLIDAY. (First published in 1876.) Crown 8vo, cloth, gilt edges, price 4_s._ 6_d._ net. Twentieth Thousand.

RHYME? AND REASON? With Sixty-five Illustrations by ARTHUR B. FROST, and nine by HENRY HOLIDAY. (First published in 1883, being a reprint, with a few additions, of the comic portion of "Phantasmagoria and other Poems," published in 1869, and of "The Hunting of the Snark," published in 1876.) Crown 8vo, cloth, gilt edges, price 4_s._ 6_d._ net. Sixth Thousand.

SYMBOLIC LOGIC. In three Parts, which will be issued separately:--

- PART I. Elementary. (First published in 1896.) Crown 8vo, limp cloth, price 2_s._ net. Second Thousand, Fourth Edition.
- PART II. Advanced. }
- PART III. Transcendental. } [In preparation.]

N.B.--An envelope, containing two blank Diagrams (Bilateral and

Symbolic Logic

Triliteral) and 9 Counters (4 Red and 5 Grey) can be had for 3_d._, by post 4_d._

px-3

A TANGLED TALE. Reprinted from _The Monthly Packet_. With Six Illustrations by ARTHUR B. FROST. (First published in 1885.) Crown 8vo, cloth, gilt edges, price 4_s._ 6_d._ net. Fourth Thousand.

SYLVIE AND BRUNO. With Forty-six Illustrations by HARRY FURNISS. (First published in 1889.) Crown 8vo, cloth, gilt edges, price 7_s._ 6_d._ net. Twelfth Thousand.

N.B.--This book contains 395 pages--nearly as much as the two Alice' books put together.

SYLVIE AND BRUNO CONCLUDED. With Forty-six Illustrations by HARRY FURNISS. (First published in 1893.) Crown 8vo, cloth, gilt edges, price 7_s._ 6_d._ net. Third Thousand.

N.B.--This book contains 411 pages.

ORIGINAL GAMES AND PUZZLES. Crown 8vo, cloth, gilt edges. [_In preparation._

THREE SUNSETS, and Other Poems. With Twelve Illustrations by E. GERTRUDE THOMSON. Fcap. 4to, cloth, gilt edges.

N.B.--This will be a reprint, possibly with a few additions, of the serious portion of "Phantasmagoria, and other Poems," published in 1869.

* * * * *

ADVICE TO WRITERS.

Buy "THE WONDERLAND CASE FOR POSTAGE-STAMPS," invented by LEWIS CARROL, Oct. 29, 1888, size 4 inches by 3, containing 12 separate pockets for stamps of different values, 2 Coloured Pictorial Surprises taken from _Alice in Wonderland_, and 8 or 9 wise words about Letter-Writing. It is published by Messrs. EMBERLIN & SON, 4 Magdalene Street, Oxford. Price 1_s._

N.B.--If ordered by Post, an additional payment will be required, to cover cost of postage, as follows:--

One copy, 1½_d._ Two or three do., 2_d._ Four do., 2½_d._ Five to fourteen do., 3_d._ Each subsequent fourteen or fraction thereof, 1½_d._

* * * * *

Transcriber's Note

This book makes extensive use of page references. To assist the reader, page markers in the forms "pg-ix", "pg193" & "px-3" have been included in the right margin at points corresponding closely to the tops of the original pages. These may be searched for to locate the material referred to. In the main section, these page markers are always given with 3 digits including, if necessary, leading zeroes.

This book contains a large number of line drawn illustrations which are un-credited. As these cannot be rendered here in the original manner

Symbolic Logic

they have been reproduced as well as possible in the manner known as "ASCII art".

A number of transcription errors were found in the original book. As these were clearly not part of the Author's intention they have, as far as possible, been identified and corrected in accordance with the methods given by the Author. These corrections are listed here below with their locations and original text. In these notes the word 'natural' identifies a letter symbol occurring without a prime mark.

- Page viii: "189" corrected to "194".
 Page viii: "188" corrected to "192".
 Page xv, '=Real=' and '=Unreal=', or '=Imaginary=', Classes: "1½" corrected to "2".
 Page xix, Propositions beginning with "Some": "18" corrected to "19".
 Page xix, Rules: "19" corrected to "20".
 Page xix, The West and East Halves ...: "24" corrected to "23".
 Page xxi, The Proposition "All x are y" ...: was originally shown as occurring in page 34.
 Page xxii, And of three other similar arrangements: "37" corrected to "36".
 Page xxiii, The Proposition 'No xm exist': "43" corrected to "44".
 Page 060: "conctruct" corrected to "construct".
 Page 094, Paper V: missing word "it" supplied.
 Page 111, #28: "No h are k-natural" corrected to "No h are k-prime".
 Page 111, #30: "No a are h-natural" corrected to "No a are h-prime".
 Page 111, #30: "No c are n-natural" corrected to "No c are n-prime".
 Page 123, #57 (d): "mortally offended if I fail to notice them" corrected to "mortally offended".
 Page 128, #34: "Some x-prime are y" corrected to "Some x-natural are y".
 Page 146, #30: " $x_{1}m\text{-prime}_{0}$ " corrected to " $x_{1}m\text{-natural}_{0}$ ".
 Page 147, #32: " $xm\text{-natural}_{0}$ " corrected to " $xm\text{-prime}_{0}$ ".
 Page 156, #18 (4/1): "be" corrected to "be-sub:zero".
 Page 156, #22 (5/1): "ch" corrected to "ch-sub:zero".
 Page 157, #23 (5/2): second underline corrected from single to double.
 Page 157, #23 (2/2): first underline corrected from single to double.
 Page 157, #23 (¶2): " $h_{1}c$ " corrected to " $h_{1}c\text{-sub:zero}$ ".
 Page 157, #26 (5/1): " $a_{1}c\text{-natural}_{0}$ " corrected to " $a_{1}c\text{-prime}_{0}$ ".
 Page 157, #26 (¶2): " $e_{1}c\text{-natural}_{0}$ " corrected to " $e_{1}c\text{-prime}_{0}$ ".
 Page 157, #29 (8/2): first underline corrected from single to double.
 Page 161, #36 (4/2): "e'd-prime" corrected to "e'd-natural".
 Page 161, #39 (1/2): "c-prime+d" corrected to "c-natural+d".
 Page 161, #40: "a" and "b" interchanged.
 Page 161, #43 (1/1): " $b\text{-natural}_{1}e_{0}$ " corrected to " $b\text{-prime}_{1}e_{0}$ ".
 Page 162, #52 (3/1): " $h'k\text{-prime}_{0}$ " corrected to " $h'k\text{-natural}_{0}$ ".
 Page 163, #55 (3/2): "c'd-prime" corrected to "c'd-natural".
 Page 163, #57 (1/2): "h-natural+d'" corrected to "h-prime+d'".

In the original book at the top of page 97, the following text occurred:

[N.B. The numbers at the foot of each page indicate the pages where the corresponding matter may be found.]

In accordance with the un-paged medium here this has been changed to:

[N.B. Reference tags for Examples, Answers & Solutions will be found in the right margin.]

The part of the book to which this relates contains, by sections, "Examples" (Exercises for the student), "Answers" (to the Examples) & "Solutions" (Worked Answers). All Example sections have corresponding Answer sections. For Sections 2 & 3, worked Solutions are not supplied; for Sections 4-7, Solutions are given by 2 different methods. In

Symbolic Logic

association with this, the original text contained editorial notes at the foot of each page giving the page numbers for the related Sections. In this version, these notes are replaced with marginal tags such as EX3, AN4, SL5, & SL6-A and SL7-B which are placed at the top of each Section to identify the current location. As with page tags, these may be searched for to locate the material referred to. (A search for "SL4" should find successively both "SL4-A" & "SL4-B".) These tags are unique regardless of case.